

# XPS 13 2-in-1 (9310 2n1)

## Service Manual



## Notes, cautions, and warnings

 **NOTE:** A NOTE indicates important information that helps you make better use of your product.

 **CAUTION:** A CAUTION indicates either potential damage to hardware or loss of data and tells you how to avoid the problem.

 **WARNING:** A WARNING indicates a potential for property damage, personal injury, or death.

<b>Chapter 1: Working inside your computer</b> .....	<b>5</b>
Before working inside your computer.....	5
Safety instructions.....	5
Electrostatic discharge—ESD protection.....	6
ESD field service kit .....	6
Transporting sensitive components.....	7
After working inside your computer.....	7
<b>Chapter 2: Removing and installing components</b> .....	<b>8</b>
Recommended tools.....	8
Screw list.....	8
Major components of XPS 13 2-in-1 (9310 2n1).....	9
Base cover.....	11
Removing the base cover.....	11
Installing the base cover.....	13
Battery.....	14
Lithium-ion battery precautions.....	14
Removing the battery.....	15
Installing the battery.....	16
Display assembly.....	18
Removing the display assembly.....	18
Installing the display assembly.....	20
Speakers.....	22
Removing the speakers.....	22
Installing the speakers.....	23
System board.....	23
Removing the system board.....	23
Installing the system board.....	26
Keyboard assembly.....	29
Removing the keyboard assembly.....	29
Installing the keyboard assembly.....	31
Palm-rest assembly.....	34
Removing the palm-rest assembly.....	34
Installing the palm-rest assembly.....	34
<b>Chapter 3: Drivers and downloads</b> .....	<b>36</b>
<b>Chapter 4: System setup</b> .....	<b>37</b>
BIOS overview.....	37
Entering BIOS setup program.....	37
Navigation keys.....	37
Boot Sequence.....	38
System setup options.....	38
Clearing CMOS settings.....	47

Clearing BIOS (System Setup) and System passwords.....	47
<b>Chapter 5: Troubleshooting.....</b>	<b>48</b>
<b>Locate the Service Tag or Express Service Code of your Dell computer .....</b>	<b>48</b>
Recovering the operating system.....	48
SupportAssist   On-board Diagnostics.....	48
System diagnostic lights.....	49
Flashing the BIOS.....	50
Flashing BIOS (USB key).....	50
WiFi power cycle.....	50
Flea power release.....	51
<b>Chapter 6: Getting help and contacting Dell.....</b>	<b>52</b>



# Working inside your computer

## Before working inside your computer

### About this task

 **NOTE:** The images in this document may differ from your computer depending on the configuration you ordered.

### Steps

1. Save and close all open files and exit all open applications.

2. Shut down your computer. Click **Start** >  **Power** > **Shut down**.

 **NOTE:** If you are using a different operating system, see the documentation of your operating system for shut-down instructions.

3. Disconnect your computer and all attached devices from their electrical outlets.

4. Disconnect all attached network devices and peripherals, such as keyboard, mouse, and monitor from your computer.

 **CAUTION:** To disconnect a network cable, first unplug the cable from your computer and then unplug the cable from the network device.

5. Remove any media card and optical disc from your computer, if applicable.

## Safety instructions

Use the following safety guidelines to protect your computer from potential damage and to ensure your personal safety. Unless otherwise noted, each procedure included in this document assumes that you have read the safety information that shipped with your computer.

 **WARNING:** Before working inside your computer, read the safety information that is shipped with your computer. For more safety best practices, see the Regulatory Compliance home page at [www.dell.com/regulatory\\_compliance](http://www.dell.com/regulatory_compliance).

 **WARNING:** Disconnect your computer from all power sources before opening the computer cover or panels. After you finish working inside the computer, replace all covers, panels, and screws before connecting your computer to an electrical outlet.

 **CAUTION:** To avoid damaging the computer, ensure that the work surface is flat, dry, and clean.

 **CAUTION:** To avoid damaging the components and cards, handle them by their edges, and avoid touching the pins and the contacts.

 **CAUTION:** You should only perform troubleshooting and repairs as authorized or directed by the Dell technical assistance team. Damage due to servicing that is not authorized by Dell is not covered by your warranty. See the safety instructions that is shipped with the product or at [www.dell.com/regulatory\\_compliance](http://www.dell.com/regulatory_compliance).

 **CAUTION:** Before touching anything inside your computer, ground yourself by touching an unpainted metal surface, such as the metal at the back of the computer. While you work, periodically touch an unpainted metal surface to dissipate static electricity which could harm internal components.

**CAUTION:** When you disconnect a cable, pull it by its connector or its pull tab, not the cable itself. Some cables have connectors with locking tabs or thumbscrews that you must disengage before disconnecting the cable. When disconnecting cables, keep them evenly aligned to avoid bending the connector pins. When connecting cables, ensure that the ports and the connectors are correctly oriented and aligned.

**CAUTION:** Press and eject any installed card from the media-card reader.

**NOTE:** The color of your computer and certain components may appear differently than shown in this document.

## Electrostatic discharge—ESD protection

ESD is a major concern when you handle electronic components, especially sensitive components such as expansion cards, processors, memory DIMMs, and system boards. Very slight charges can damage circuits in ways that may not be obvious, such as intermittent problems or a shortened product life span. As the industry pushes for lower power requirements and increased density, ESD protection is an increasing concern.

Due to the increased density of semiconductors used in recent Dell products, the sensitivity to static damage is now higher than in previous Dell products. For this reason, some previously approved methods of handling parts are no longer applicable.

Two recognized types of ESD damage are catastrophic and intermittent failures.

- **Catastrophic** – Catastrophic failures represent approximately 20 percent of ESD-related failures. The damage causes an immediate and complete loss of device functionality. An example of catastrophic failure is a memory DIMM that has received a static shock and immediately generates a "No POST/No Video" symptom with a beep code emitted for missing or nonfunctional memory.
- **Intermittent** – Intermittent failures represent approximately 80 percent of ESD-related failures. The high rate of intermittent failures means that most of the time when damage occurs, it is not immediately recognizable. The DIMM receives a static shock, but the tracing is merely weakened and does not immediately produce outward symptoms related to the damage. The weakened trace may take weeks or months to melt, and in the meantime may cause degradation of memory integrity, intermittent memory errors, etc.

The more difficult type of damage to recognize and troubleshoot is the intermittent (also called latent or "walking wounded") failure.

Perform the following steps to prevent ESD damage:

- Use a wired ESD wrist strap that is properly grounded. The use of wireless anti-static straps is no longer allowed; they do not provide adequate protection. Touching the chassis before handling parts does not ensure adequate ESD protection on parts with increased sensitivity to ESD damage.
- Handle all static-sensitive components in a static-safe area. If possible, use anti-static floor pads and workbench pads.
- When unpacking a static-sensitive component from its shipping carton, do not remove the component from the anti-static packing material until you are ready to install the component. Before unwrapping the anti-static packaging, ensure that you discharge static electricity from your body.
- Before transporting a static-sensitive component, place it in an anti-static container or packaging.

## ESD field service kit

The unmonitored Field Service kit is the most commonly used service kit. Each Field Service kit includes three main components: anti-static mat, wrist strap, and bonding wire.

### Components of an ESD field service kit

The components of an ESD field service kit are:

- **Anti-Static Mat** – The anti-static mat is dissipative and parts can be placed on it during service procedures. When using an anti-static mat, your wrist strap should be snug and the bonding wire should be connected to the mat and to any bare metal on the system being worked on. Once deployed properly, service parts can be removed from the ESD bag and placed directly on the mat. ESD-sensitive items are safe in your hand, on the ESD mat, in the system, or inside a bag.
- **Wrist Strap and Bonding Wire** – The wrist strap and bonding wire can be either directly connected between your wrist and bare metal on the hardware if the ESD mat is not required, or connected to the anti-static mat to protect hardware that is temporarily placed on the mat. The physical connection of the wrist strap and bonding wire between your skin, the ESD

mat, and the hardware is known as bonding. Use only Field Service kits with a wrist strap, mat, and bonding wire. Never use wireless wrist straps. Always be aware that the internal wires of a wrist strap are prone to damage from normal wear and tear, and must be checked regularly with a wrist strap tester in order to avoid accidental ESD hardware damage. It is recommended to test the wrist strap and bonding wire at least once per week.

- **ESD Wrist Strap Tester** – The wires inside of an ESD strap are prone to damage over time. When using an unmonitored kit, it is a best practice to regularly test the strap prior to each service call, and at a minimum, test once per week. A wrist strap tester is the best method for doing this test. If you do not have your own wrist strap tester, check with your regional office to find out if they have one. To perform the test, plug the wrist-strap's bonding-wire into the tester while it is strapped to your wrist and push the button to test. A green LED is lit if the test is successful; a red LED is lit and an alarm sounds if the test fails.
- **Insulator Elements** – It is critical to keep ESD sensitive devices, such as plastic heat sink casings, away from internal parts that are insulators and often highly charged.
- **Working Environment** – Before deploying the ESD Field Service kit, assess the situation at the customer location. For example, deploying the kit for a server environment is different than for a desktop or portable environment. Servers are typically installed in a rack within a data center; desktops or portables are typically placed on office desks or cubicles. Always look for a large open flat work area that is free of clutter and large enough to deploy the ESD kit with additional space to accommodate the type of system that is being repaired. The workspace should also be free of insulators that can cause an ESD event. On the work area, insulators such as Styrofoam and other plastics should always be moved at least 12 inches or 30 centimeters away from sensitive parts before physically handling any hardware components
- **ESD Packaging** – All ESD-sensitive devices must be shipped and received in static-safe packaging. Metal, static-shielded bags are preferred. However, you should always return the damaged part using the same ESD bag and packaging that the new part arrived in. The ESD bag should be folded over and taped shut and all the same foam packing material should be used in the original box that the new part arrived in. ESD-sensitive devices should be removed from packaging only at an ESD-protected work surface, and parts should never be placed on top of the ESD bag because only the inside of the bag is shielded. Always place parts in your hand, on the ESD mat, in the system, or inside an anti-static bag.
- **Transporting Sensitive Components** – When transporting ESD sensitive components such as replacement parts or parts to be returned to Dell, it is critical to place these parts in anti-static bags for safe transport.

## ESD protection summary

It is recommended that all field service technicians use the traditional wired ESD grounding wrist strap and protective anti-static mat at all times when servicing Dell products. In addition, it is critical that technicians keep sensitive parts separate from all insulator parts while performing service and that they use anti-static bags for transporting sensitive components.

## Transporting sensitive components

When transporting ESD sensitive components such as replacement parts or parts to be returned to Dell, it is critical to place these parts in anti-static bags for safe transport.

## After working inside your computer

### About this task

 **CAUTION:** Leaving stray or loose screws inside your computer may severely damage your computer.

### Steps

1. Replace all screws and ensure that no stray screws remain inside your computer.
2. Connect any external devices, peripherals, or cables you removed before working on your computer.
3. Replace any media cards, discs, or any other parts that you removed before working on your computer.
4. Connect your computer and all attached devices to their electrical outlets.
5. Turn on your computer.

# Removing and installing components

**NOTE:** The images in this document may differ from your computer depending on the configuration you ordered.

## Recommended tools

The procedures in this document may require the following tools:

- Phillips screwdriver #00
- Phillips screwdriver #0
- Torx screwdriver T5
- Flat-head screwdriver
- Plastic scribe









## Screw list

**NOTE:** When removing screws from a component, it is recommended to note the screw type, the quantity of screws, and then place them in a screw storage box. This is to ensure that the correct number of screws and correct screw type is restored when the component is replaced.





**NOTE:** Some computers have magnetic surfaces. Ensure that the screws are not left attached to such surfaces when replacing a component.

**NOTE:** Screw color may vary with the configuration ordered.

**Table 1. Screw list**

Component	Secured to	Screw type	Quantity	Screw image
Base cover	Palm-rest assembly	M2x4.5	8 Torx screws	
Battery	System board	M1.6x3.4	1 Torx screw	
Battery	Palm-rest assembly	M1.6x3	7	
Battery	Palm-rest assembly	M1.2x4	2	
Display-cable bracket	System board	M1.6x3	1 captive screw on display-cable bracket	
Display assembly	Palm-rest assembly	M2.5x3	4	
USB Type-C bracket	System board	M1.6x3	1	
USB Type-C bracket	System board	M1.6x2	1	

**Table 1. Screw list (continued)**

<b>Component</b>	<b>Secured to</b>	<b>Screw type</b>	<b>Quantity</b>	<b>Screw image</b>
System board	Palm-rest assembly	M1.6x2.5	4	
System board	Palm-rest assembly	M1.2x3	3	
System board	Palm-rest assembly	M1.2x4	1 captive screw	
Keyboard assembly	Palm-rest assembly	M1.2x1.4	38	
Keyboard assembly	Palm-rest assembly	M1.2x1.6	10	

## Major components of XPS 13 2-in-1 (9310 2n1)

The following image shows the major components of XPS 13 2-in-1 (9310 2n1).

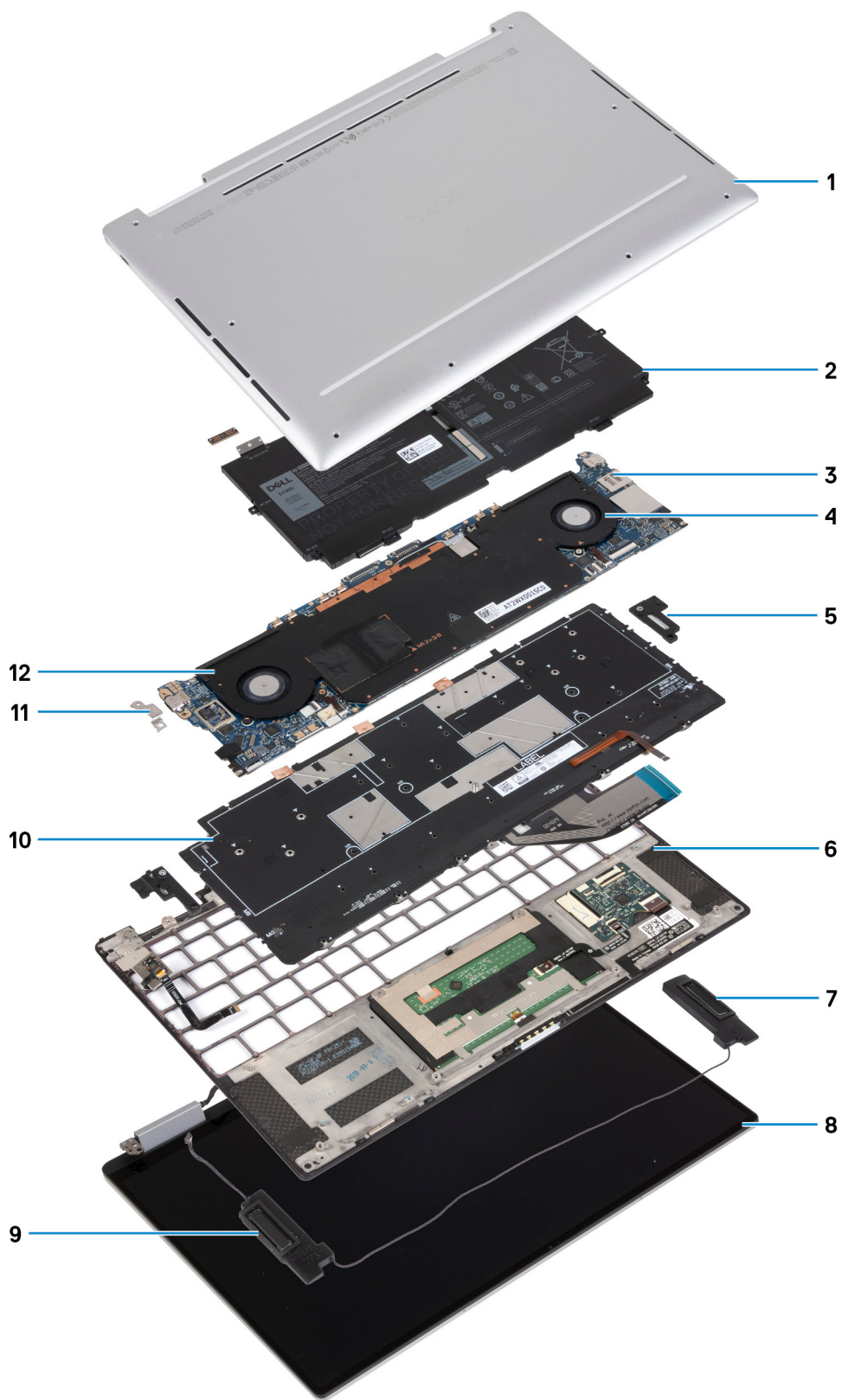

1. Base cover
2. Battery
3. System board
4. Left fan
5. Left keyboard bracket

6. Palm-rest assembly
7. Left speaker
8. Display assembly
9. Right speaker
10. Keyboard assembly
11. USB Type-C port bracket
12. Right fan

**NOTE:** Dell provides a list of components and their part numbers for the original system configuration purchased. These parts are available according to warranty coverages purchased by the customer. Contact your Dell sales representative for purchase options.

## Base cover

### Removing the base cover

#### Prerequisites

1. Follow the procedure in [Before working inside your computer](#).

#### About this task

The following images indicate the location of the base cover and provide a visual representation of the removal procedure.



**8x**  
M2x4.5









## Steps

1. Remove the eight Torx screws (M2x4.5) that secure the base cover to the palm-rest assembly.
2. Starting from the bottom-left corner, pry the base cover in the direction of the arrows to release it from the palm-rest assembly.

 **CAUTION:** Do not pull on or pry the base cover from the top as it may damage the base cover.

3. Hold both sides of the base cover and rotate from front to back to remove from palm rest assembly.

 **NOTE:** The pins at the bottom of the base cover for grounding the antennas and the audio board are fragile. Place the base cover on a clean surface to avoid damage to the pins.

## Installing the base cover

### Prerequisites

If you are replacing a component, remove the existing component before performing the installation procedure.

### About this task

The following images indicate the location of the base cover and provide a visual representation of the installation procedure.





**8x**  
M2x4.5

**2**



### Steps

1. Align and secure the back of the base cover on the palm-rest assembly, and then snap the base cover into place.
2. Replace the eight Torx screws (M2x4.5) that secure the base cover to the palm-rest assembly.

### Next steps

1. Follow the procedure in [After working inside your computer](#).

## Battery

### Lithium-ion battery precautions

#### CAUTION:

- Exercise caution when handling Lithium-ion batteries.
- Discharge the battery completely before removing it. Disconnect the AC power adapter from the system and operate the computer solely on battery power—the battery is fully discharged when the computer no longer turns on when the power button is pressed.
- Do not crush, drop, mutilate, or penetrate the battery with foreign objects.
- Do not expose the battery to high temperatures, or disassemble battery packs and cells.

- Do not apply pressure to the surface of the battery.
- Do not bend the battery.
- Do not use tools of any kind to pry on or against the battery.
- Ensure any screws during the servicing of this product are not lost or misplaced, to prevent accidental puncture or damage to the battery and other system components.
- If the battery gets stuck inside your computer as a result of swelling, do not try to release it as puncturing, bending, or crushing a lithium-ion battery can be dangerous. In such an instance, contact Dell technical support for assistance. See [www.dell.com/contactdell](http://www.dell.com/contactdell).
- Always purchase genuine batteries from [www.dell.com](http://www.dell.com) or authorized Dell partners and resellers.

## Removing the battery

### Prerequisites

1. Follow the procedure in [Before working inside your computer](#).
2. Remove the [base cover](#).

### About this task

The following image indicates the location of the battery and provides a visual representation of the removal procedure.

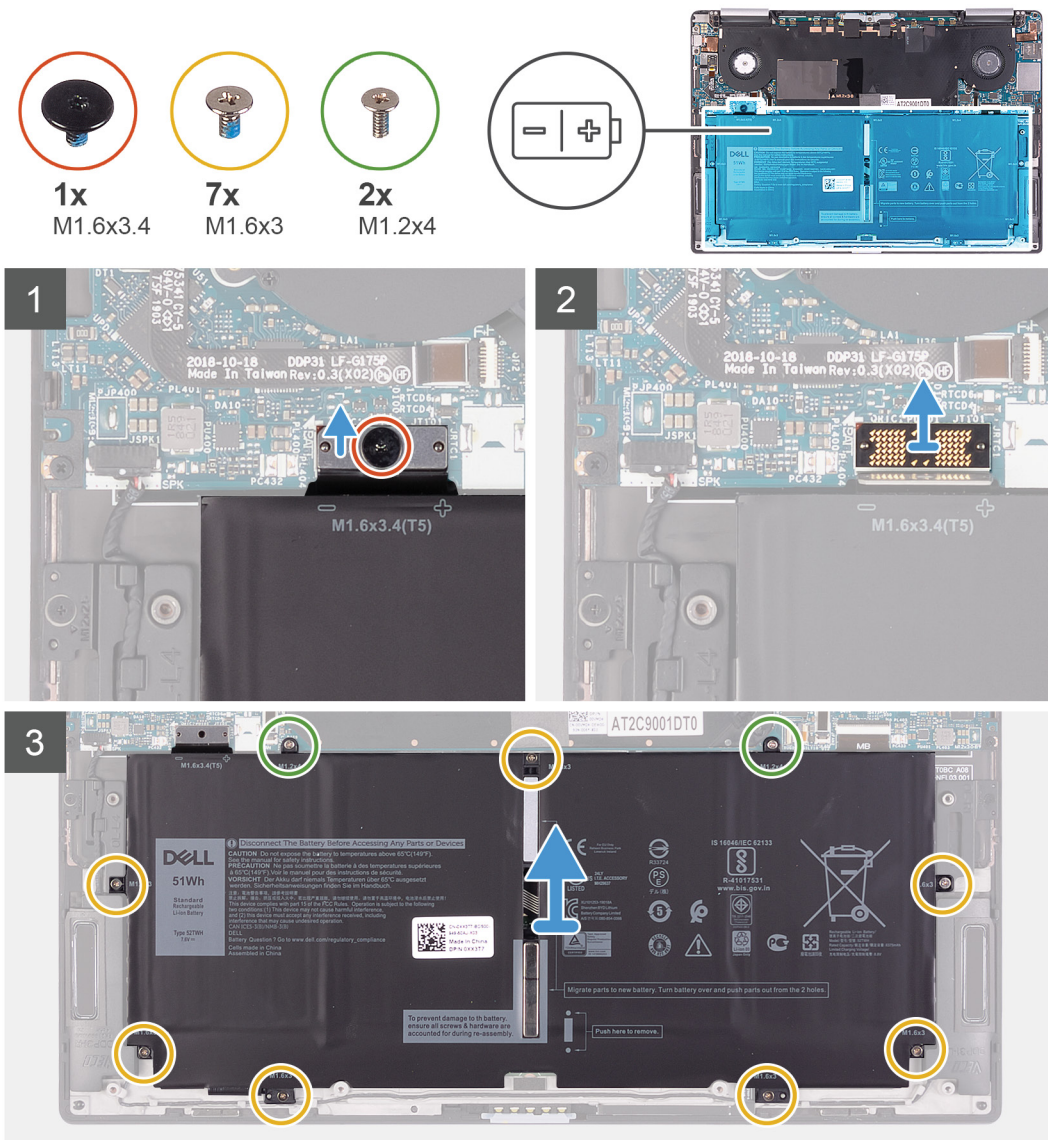

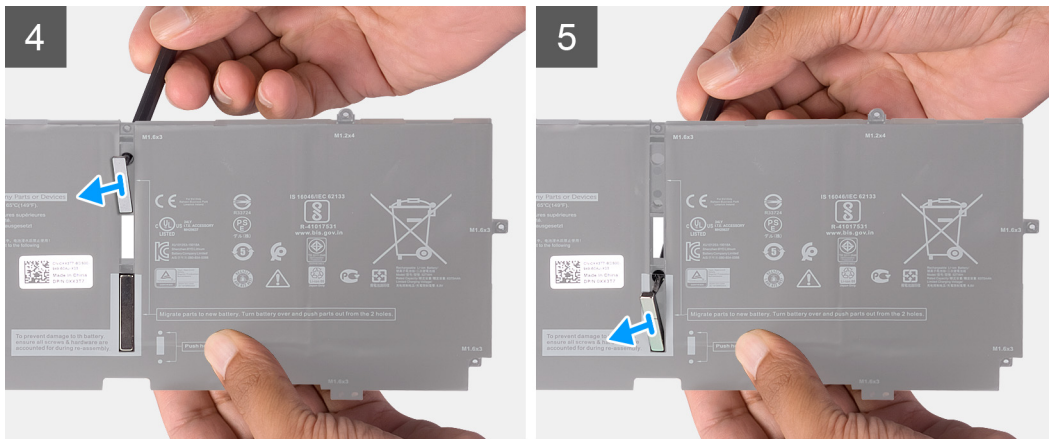

## Steps

1. Remove the Torx 5 screw (M1.6x3.4) that secures the battery cable to the system board.
2. Disconnect the battery cable from the interposer board.
  - i** **NOTE:** Remove the interposer board immediately after disconnecting the battery cable to avoid misplacing it. Hold the edges of the interposer board to avoid damaging the pins on it.
  - i** **NOTE:** The interposer board is not polarity sensitive and both sides are compatible.
3. Remove the interposer board from the system board.
4. Remove the seven screws (M1.6x3) that secure the battery to the palm-rest assembly.
5. Remove the two screws (M1.2x4) that secure the battery to the system board.
6. Lift the battery off the palm-rest assembly.
7. Turn the battery over.
8. Using a plastic scribe, push to remove the magnet and the metal bar from the battery.
  - i** **NOTE:** Keep the magnet and the metal bar as they need to be installed on the new battery.

## Installing the battery

### Prerequisites

If you are replacing a component, remove the existing component before performing the installation procedure.

### About this task

The following image indicates the location of the battery and provides a visual representation of the installation procedure.



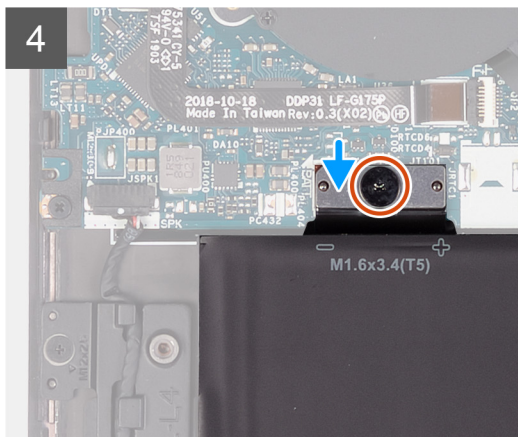
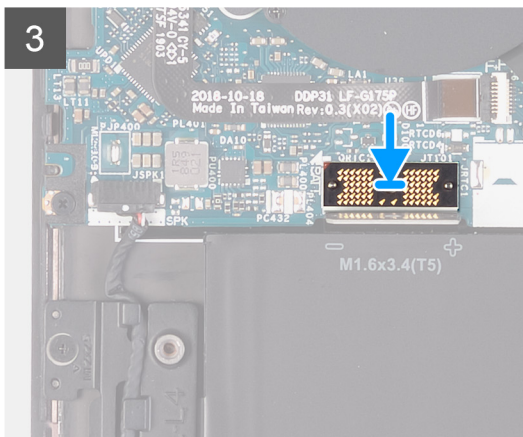
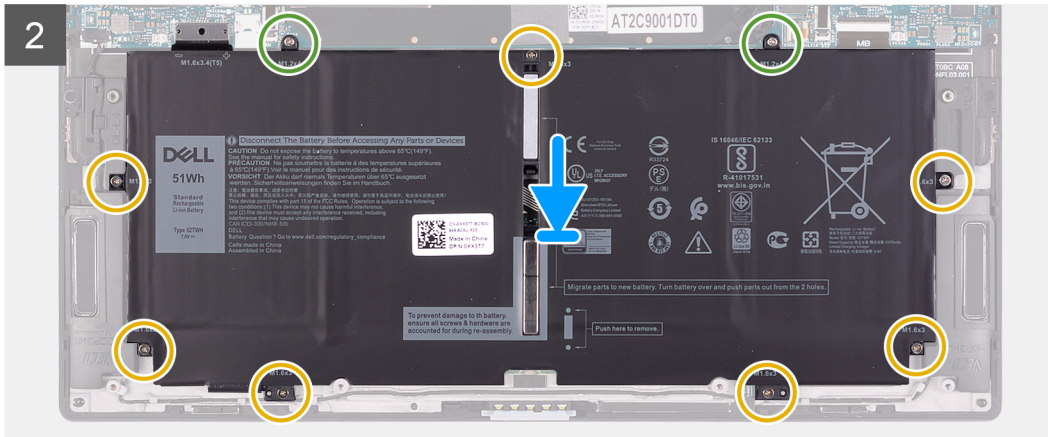
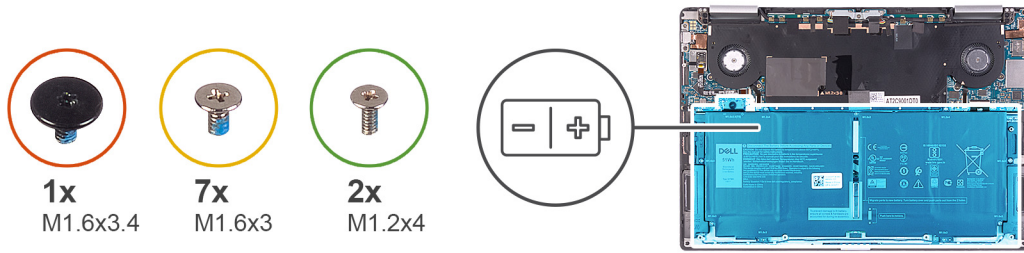

## Steps

- Adhere the magnet and the metal bar to the battery.
  - NOTE:** Install the magnet and the metal bar from the faulty battery.
- Align the screw holes on the battery with the screw holes on the system board and palm-rest assembly.
- Replace the two screws (M1.2x4) that secure the battery to the system board.
- Replace the seven screws (M1.6x3) that secure the battery to the palm-rest assembly.
- Place the interposer board to the connector on the system board.
  - NOTE:** The interposer board is not polarity sensitive and both sides are compatible.
- Connect the battery cable to the interposer board.
- Replace the Torx 5 screw (M1.6x3.4) that secures the battery cable to the system board.

## Next steps

- Install the [base cover](#).
- Follow the procedure in [After working inside your computer](#).

# Display assembly

## Removing the display assembly

### Prerequisites

1. Follow the procedure in [Before working inside your computer](#).
2. Remove the [base cover](#).
3. Remove the [battery](#).

### About this task

The following images indicate the location of display assembly and provide a visual representation of the removal procedure.



1x  
M1.6x3



4x  
M2.5x3

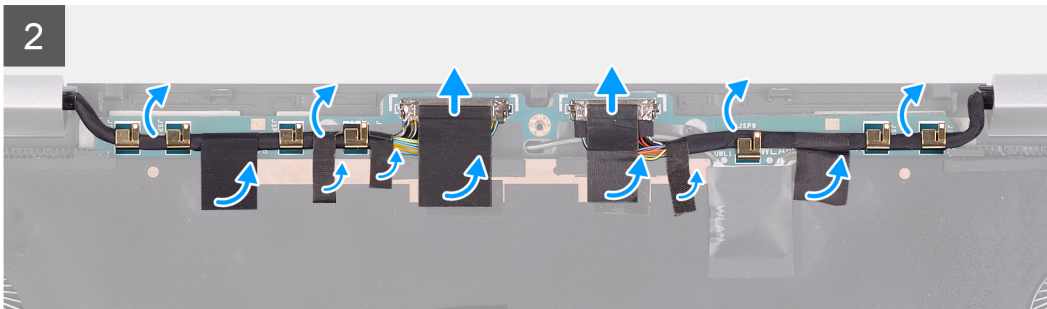
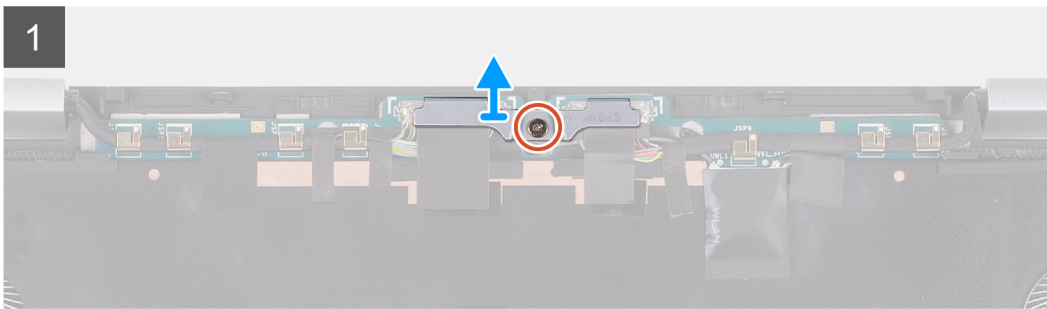
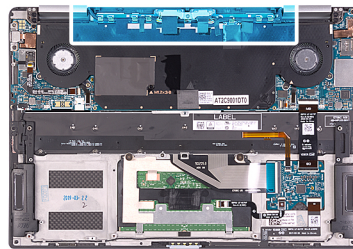

3

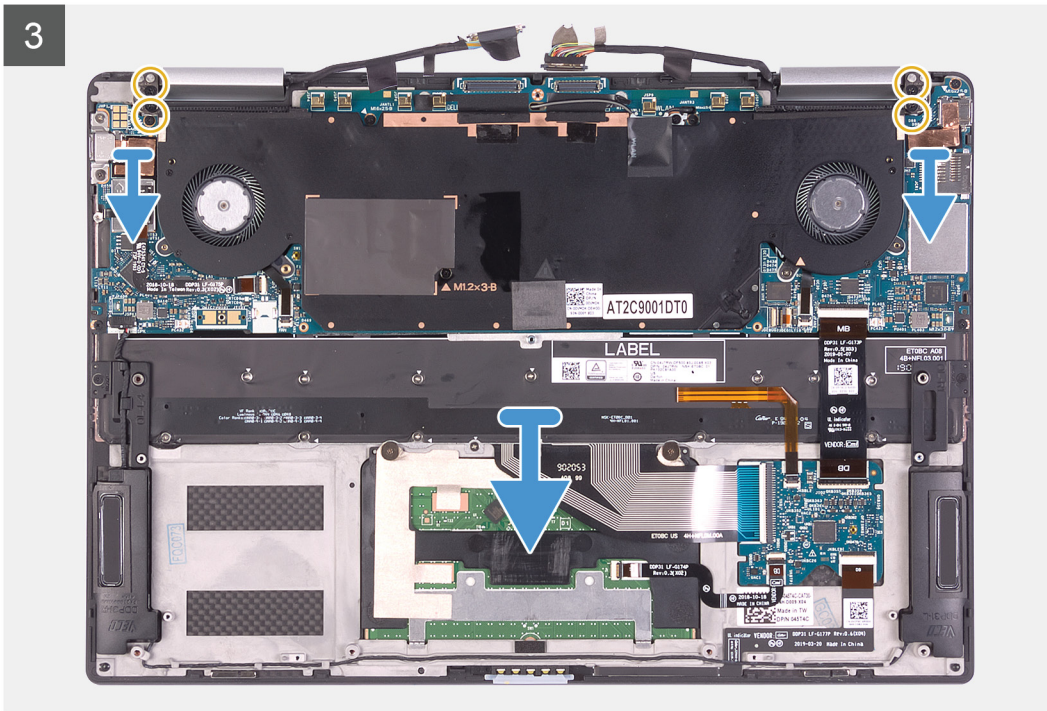

### Steps

1. Loosen the captive screw (M1.6x3) that secures the display-cable bracket to the system board.
2. Lift the display-cable bracket off the system board.
3. Peel the tapes that secure the display cable and camera cable to the system board.
4. Using the tape as a pull tab, disconnect the display cable and camera cable from the system board.
5. Remove the display cable and camera cable from the routing guides on the system board.
6. Remove the four screws (M2.5x3) that secure the display hinges to the palm-rest assembly.
7. Slide the palm-rest assembly off the display assembly.



## Installing the display assembly

### Prerequisites

If you are replacing a component, remove the existing component before performing the installation procedure.

### About this task

The following images indicate the location of display assembly and provide a visual representation of the installation procedure.



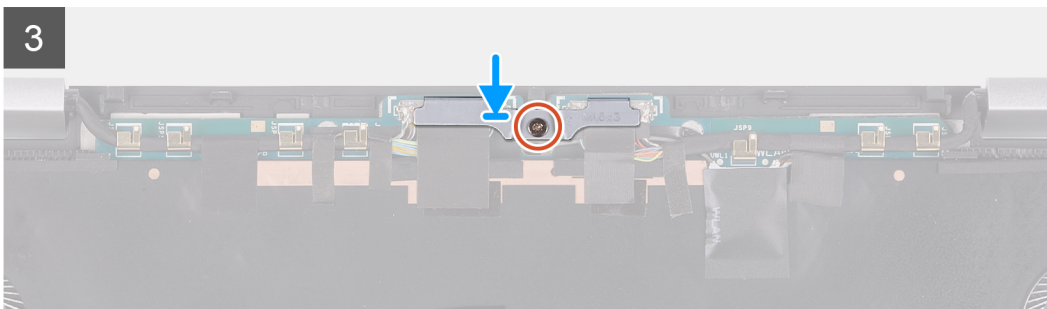
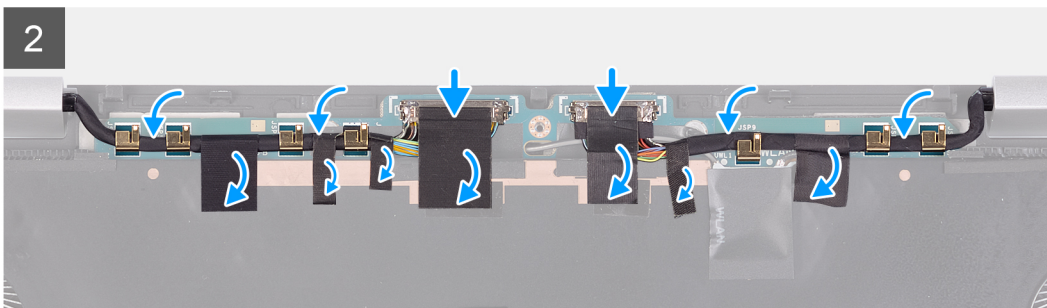
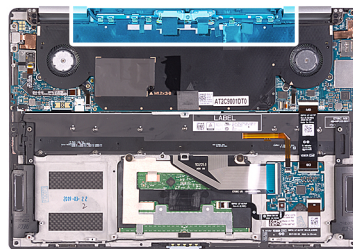
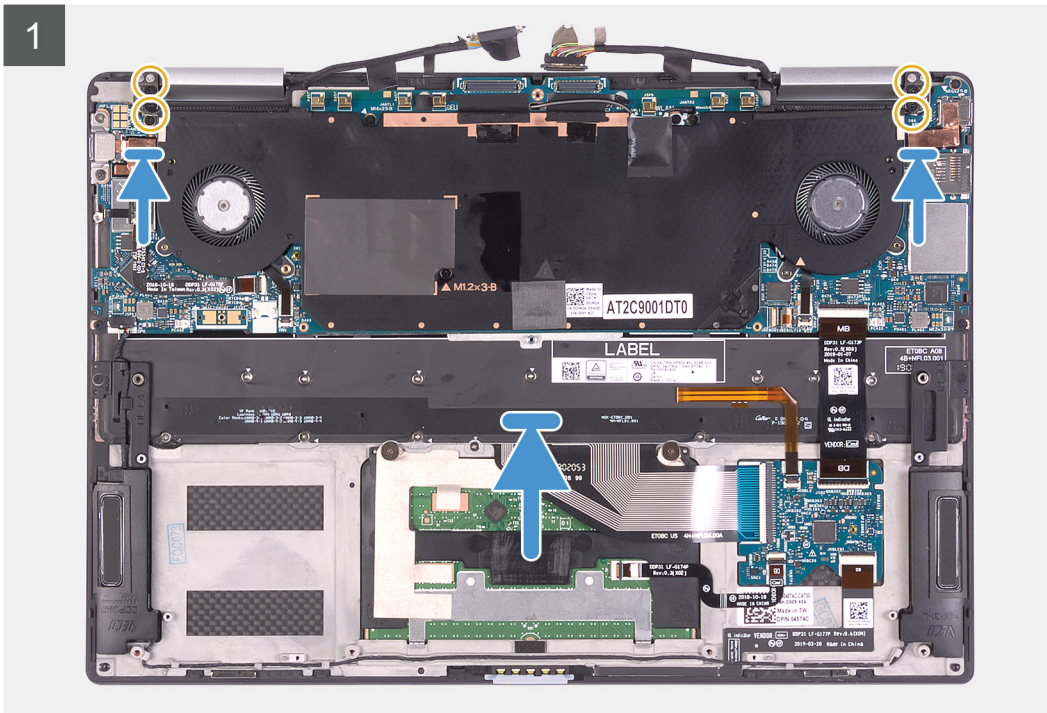

**Steps**

1. Slide the palm-rest assembly under the display assembly.
2. Align the screw holes on the palm-rest assembly with the screw holes on the display hinges.
3. Replace the four screws (M2.5x3) that secure the display hinges to the palm-rest assembly.
4. Route the display cable and camera cable through the routing guides on the system board.

5. Connect the display cable and camera cable to the system board.
6. Adhere the tapes that secure the display cable and camera cable to the system board.
7. Align and place the display-cable bracket on the system board.
8. Tighten the captive screw (M1.6x3) that secures the display-cable bracket to the system board.

### Next steps

1. Install the [battery](#).
2. Install the [base cover](#).
3. Follow the procedure in [After working inside your computer](#).

## Speakers

### Removing the speakers

#### Prerequisites

1. Follow the procedure in [Before working inside your computer](#).
2. Remove the [base cover](#).
3. Remove the [battery](#).

#### About this task

The following image indicates the location of speakers and provides a visual representation of the removal procedure.

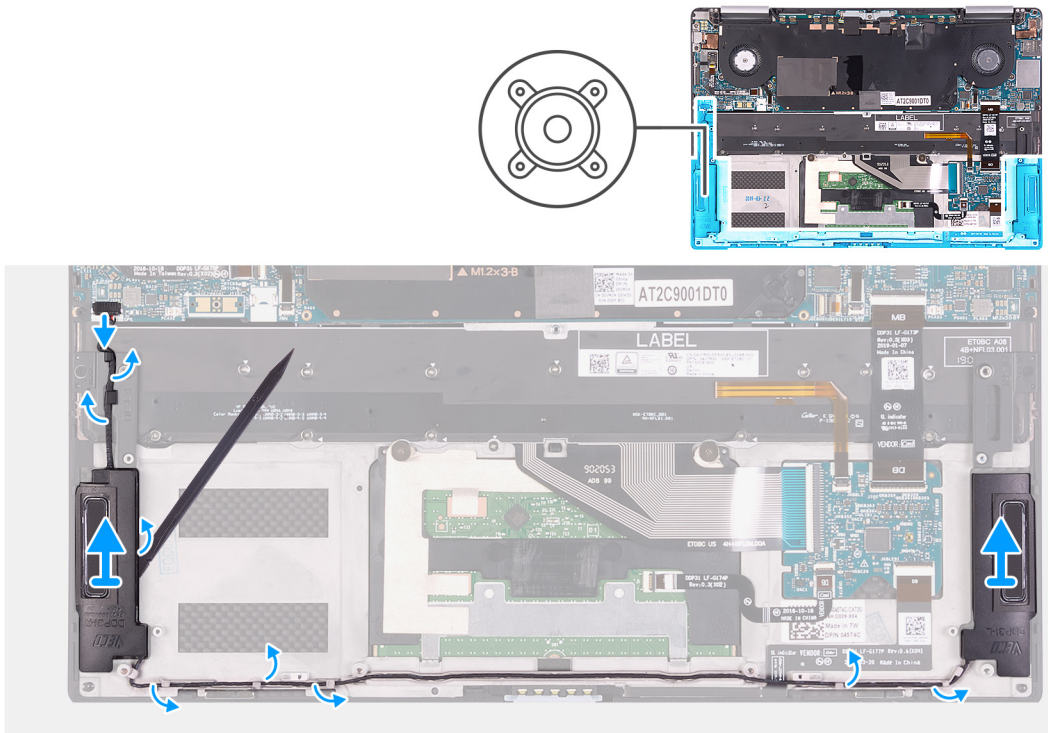

#### Steps

1. Disconnect the speaker cable from the system board.
2. Note the routing of the speaker cable and remove the speaker cable from the routing guides on the palm-rest assembly.
3. Using a plastic scribe, pry the speakers off the palm-rest assembly.

# Installing the speakers

## Prerequisites

If you are replacing a component, remove the existing component before performing the installation procedure.

## About this task

The following image indicates the location of speakers and provides a visual representation of the installation procedure.

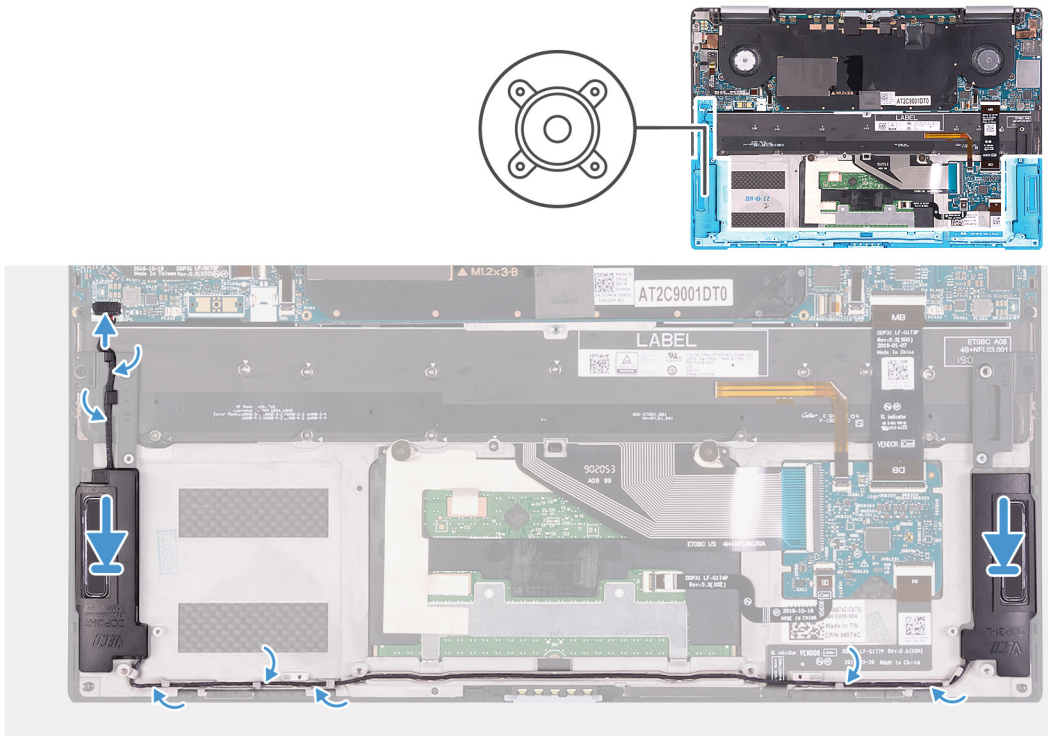

## Steps

1. Slide the speakers into the slots on the palm-rest assembly.  
**NOTE:** Ensure that there is no adhesive residue from the faulty speakers that are removed previously.
2. Route the speaker cable through the routing guides on the palm-rest assembly.
3. Connect the speaker cable to the system board.

## Next steps

1. Install the [battery](#).
2. Install the [base cover](#).
3. Follow the procedure in [After working inside your computer](#).

# System board

## Removing the system board

### Prerequisites

1. Follow the procedure in [Before working inside your computer](#).
2. Remove the [base cover](#).
3. Remove the [battery](#).



### About this task

The following image indicates the connectors on your system board.

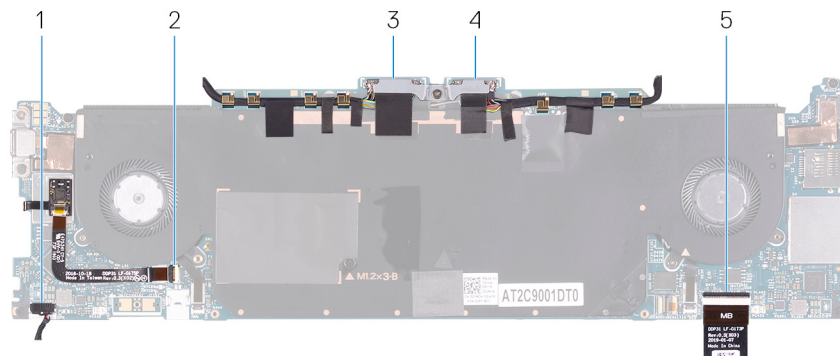

**Figure 1. System-board connectors**

- 1. Speaker cable
- 2. Fingerprint-reader cable
- 3. Display cable
- 4. Camera cable
- 5. Keyboard-controller board cable

The following images indicate the location of system board and provide a visual representation of the removal procedure.



**1x**  
M1.6x3

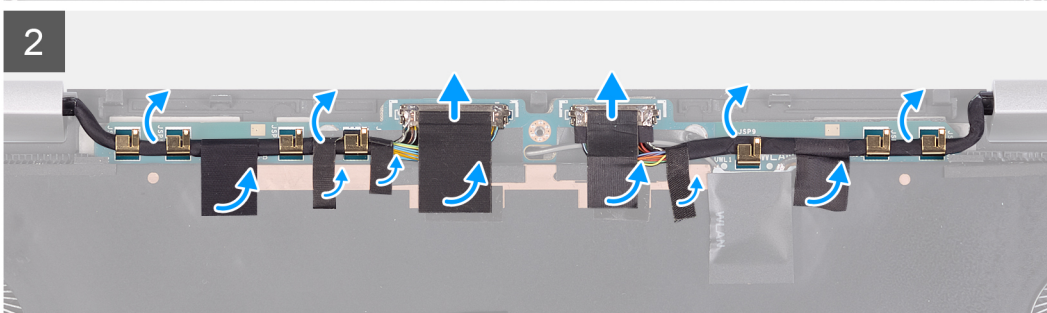
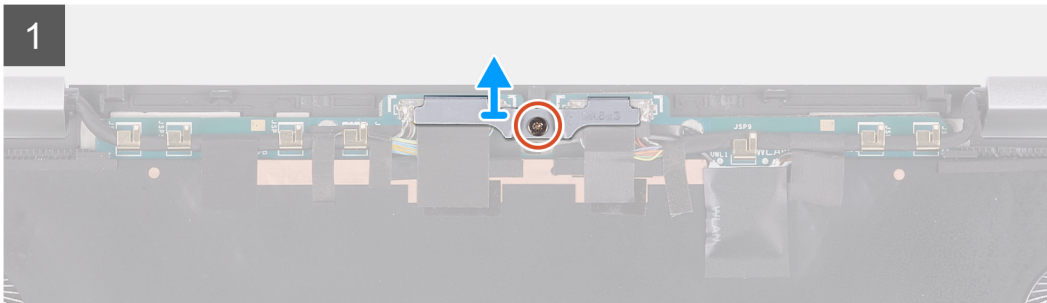
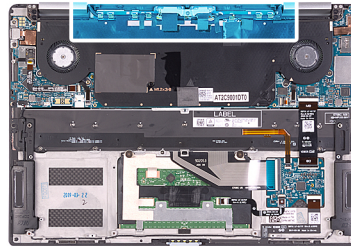

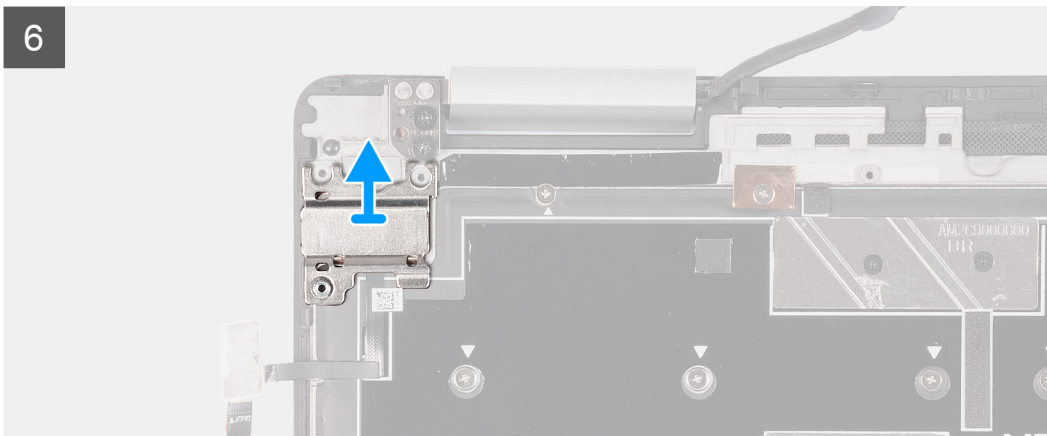
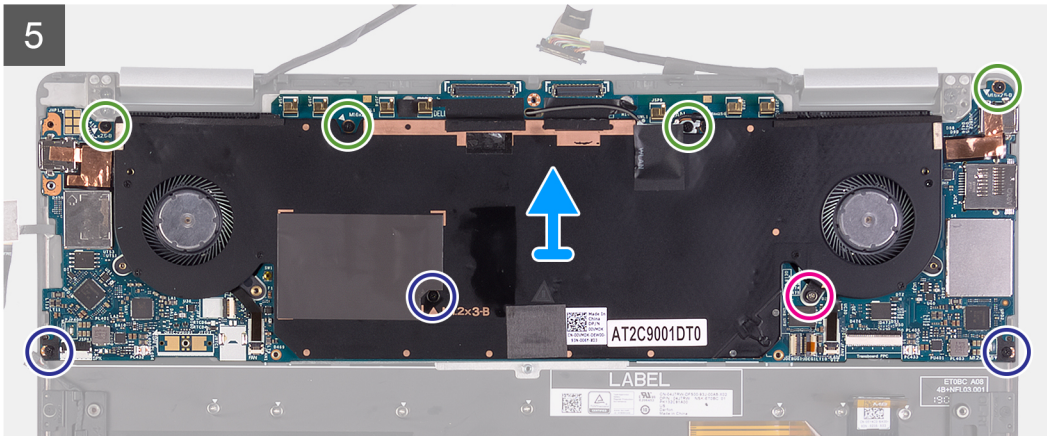
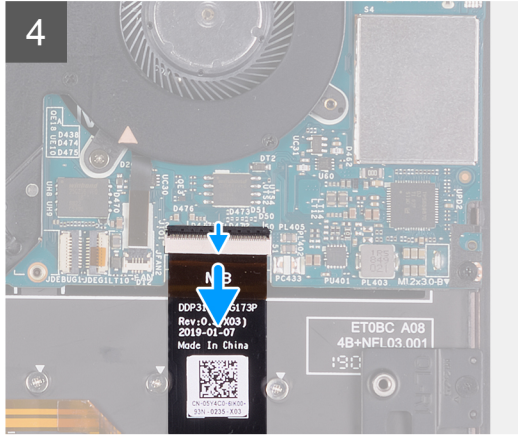
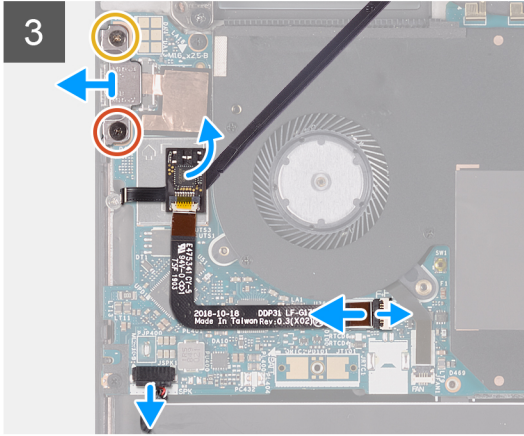
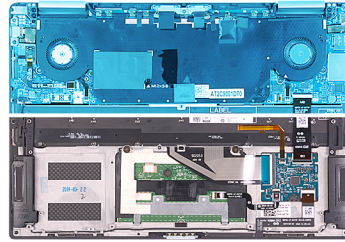
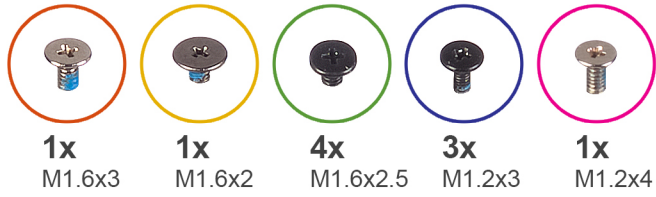

### Steps

1. Loosen the captive screw (M1.6x3) that secures the display-cable bracket to the system board.
2. Lift the display-cable bracket off the system board.
3. Peel the tapes that secure the display cable and camera cable to the system board.
4. Using the tape as a pull tab, disconnect the display cable and camera cable from the system board.

5. Remove the display cable and camera cable from the routing guides on the system board.
6. Remove the screw (M1.6x3) and the screw (M1.6x2) that secures the type-C bracket to the system board.
  - NOTE:** The M1.6x2 screw has a bigger head than the M1.6x3 screw.
7. Lift the type-C bracket off the system board.
8. Disconnect the speaker cable from the system board.
9. Open the latch and disconnect the fingerprint-reader cable from the system board.
10. Peel off the fingerprint-reader daughter-board from the system board.
11. Open the latch and disconnect the keyboard-controller board cable from the system board.
12. Remove the four screws (M1.6x2.5), three screws (M1.2x3), and one captive screw (M1.2x4) that secure the system board to the palm-rest assembly.
13. Lift the system board off the palm-rest assembly.
14. Remove the power-button and fingerprint reader bracket from the palm-rest assembly.
15. Place the bracket and the system board on a dry, flat, and clean surface.

## Installing the system board

### Prerequisites

If you are replacing a component, remove the existing component before performing the installation procedure.

### About this task

The following image indicates the connectors on your system board.

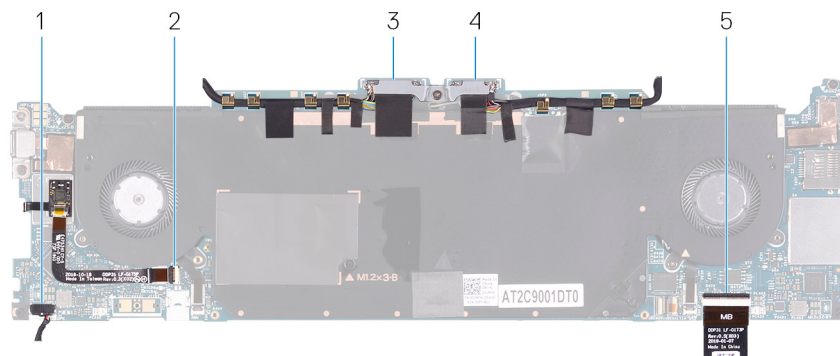
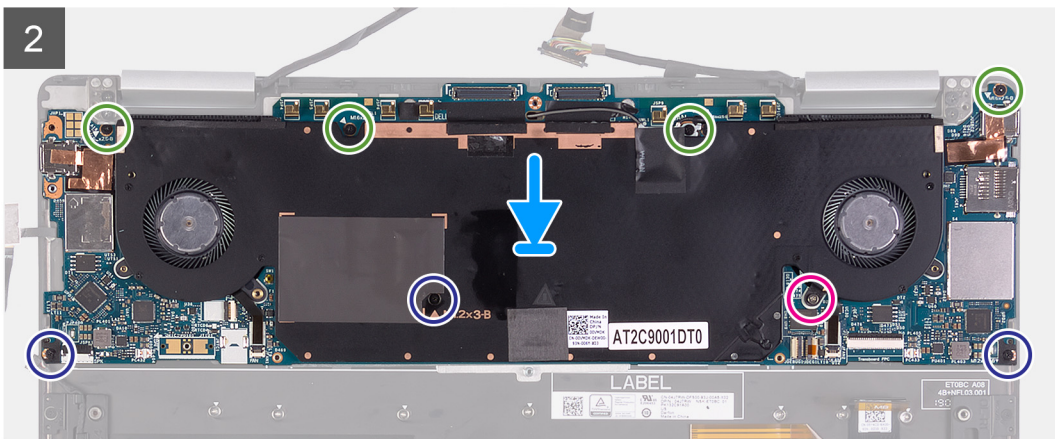
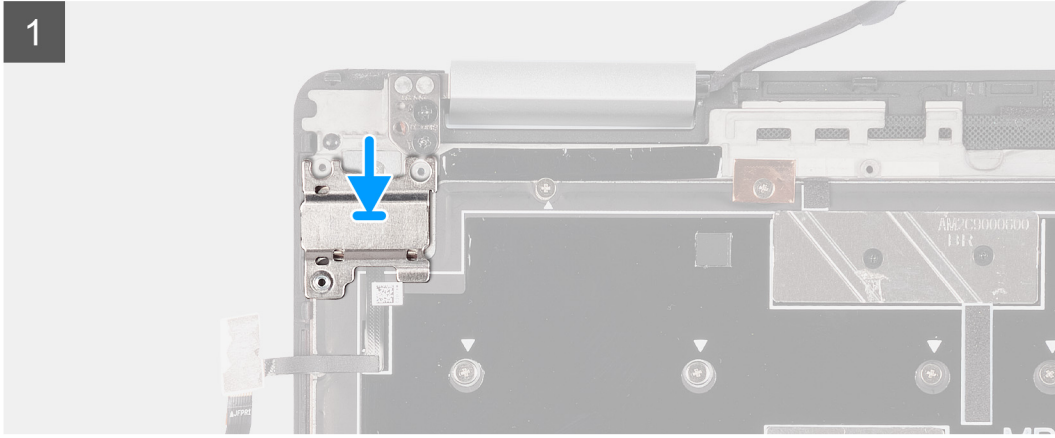
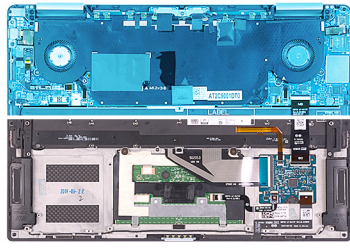
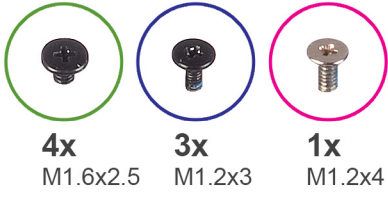

**Figure 2. System-board connectors**

- |                                    |                             |
|------------------------------------|-----------------------------|
| 1. Speaker cable                   | 2. Fingerprint-reader cable |
| 3. Display cable                   | 4. Camera cable             |
| 5. Keyboard-controller board cable |                             |

The following images indicate the location of system board and provide a visual representation of the installation procedure.





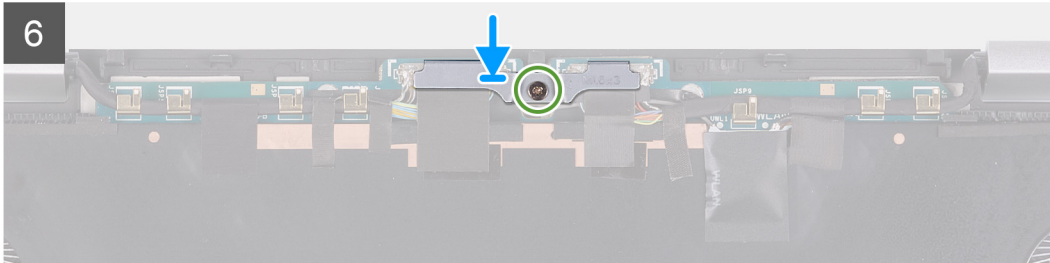
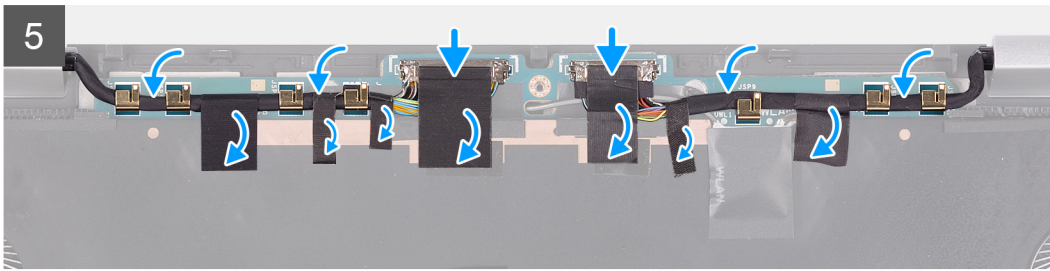
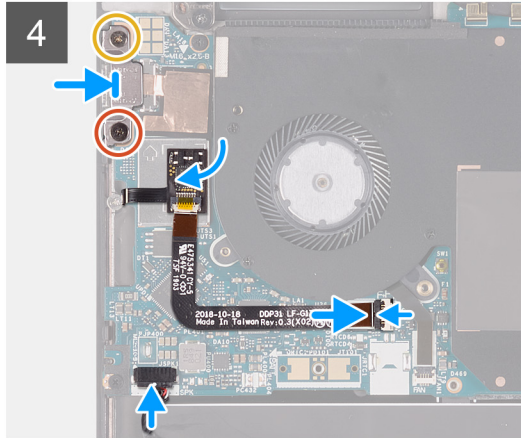
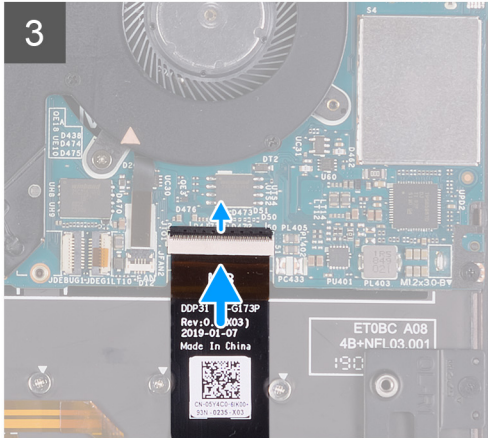
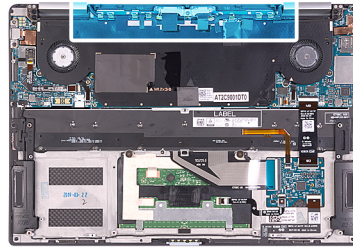
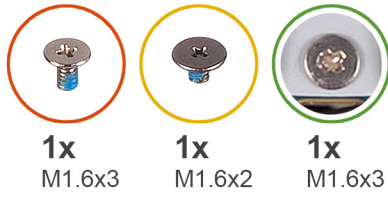

### Steps

1. Align and place the power-button and fingerprint reader bracket on the palm-rest assembly.
2. Align the screw holes on the system board with the screw holes on the palm-rest assembly.
3. Replace the four screws (M2x4), three screws (M1.2x3), and one screw (M1.2x4) that secure the system board to the palm-rest assembly.
4. Connect the keyboard-controller board cable to the system board and close the latch to secure the cable.
5. Connect the speaker cable to the system board.
6. Adhere the fingerprint-reader board to the slot on the system board.
7. Connect the fingerprint-reader cable to the system board and close the latch to secure the cable.
8. Align the screw holes on the USB Type-C bracket to the screw holes on the system board.
9. Replace the screw (M1.6x3) and the screw (M1.6x2) that secures the USB Type-C port bracket to the system board.
  - NOTE:** The M1.6x2 screw has a bigger head than the M1.6x3 screw.
10. Route the display cable and camera cable through the routing guides on the system board.
11. Connect the display cable and camera cable to the system board.



12. Adhere the tapes that secure the display cable and camera cable to the system board.
13. Align and place the display-cable bracket on the system board.
14. Tighten the captive screw (M1.6x3) that secures the display-cable bracket to the system board.

#### Next steps

1. Install the [battery](#).
2. Install the [base cover](#).
3. Follow the procedure in [After working inside your computer](#).

## Keyboard assembly

### Removing the keyboard assembly

#### Prerequisites

1. Follow the procedure in [Before working inside your computer](#).
2. Remove the [base cover](#).
3. Remove the [battery](#).
4. Remove the [system board](#).

#### About this task

The following images indicate the location of keyboard assembly and provide a visual representation of the removal procedure.



**2x**  
M1.2x2.5



**38x**  
M1.2x1.4



**10x**  
M1.2x1.6

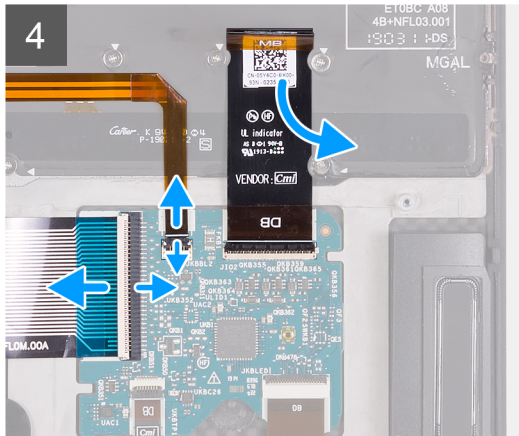
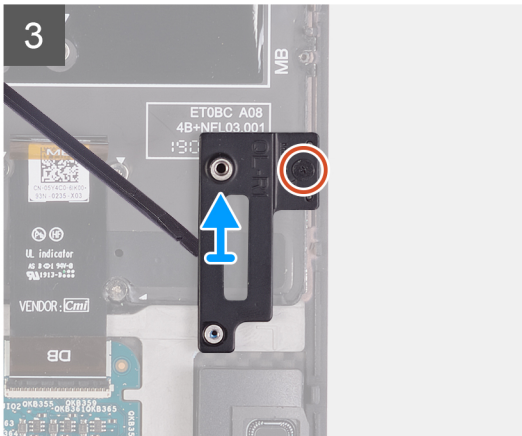
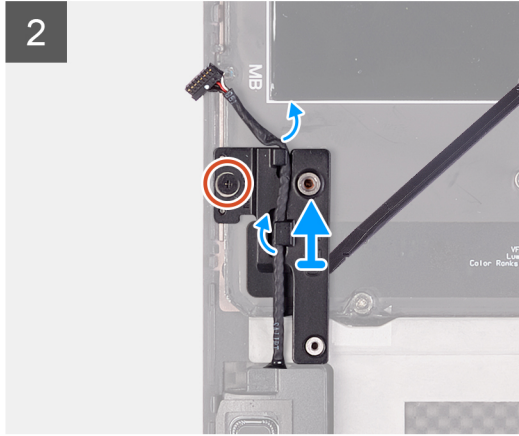
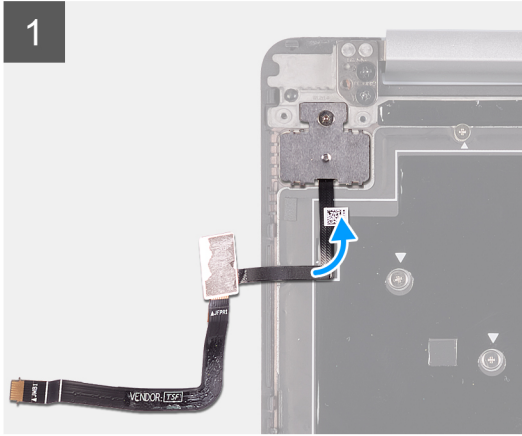
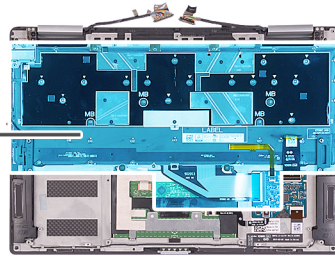

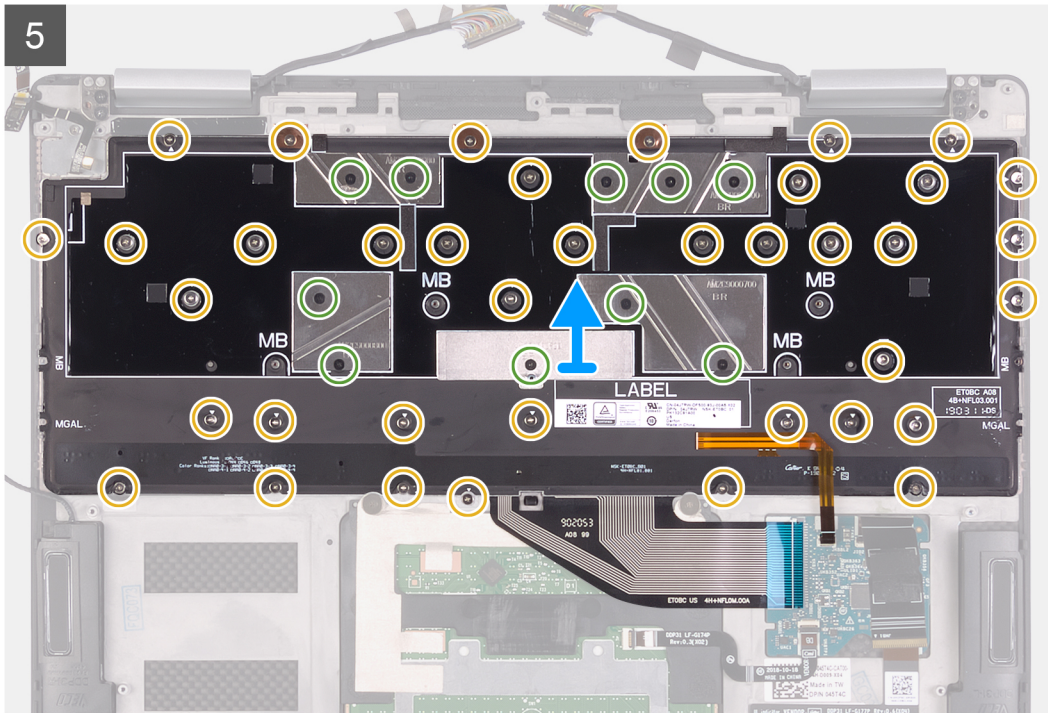

## Steps

1. Peel the fingerprint reader cable from the keyboard.
2. Remove the speaker cable from the routing guides on the left keyboard bracket.
3. Loosen the captive screw that secures the left keyboard bracket to the palm-rest assembly.
4. Using a plastic scribe, pry the left keyboard bracket off the palm-rest assembly.
5. Loosen the captive screw that secures the right keyboard bracket to the palm-rest assembly.
6. Using a plastic scribe, pry the right keyboard bracket off the palm-rest assembly.
7. Disconnect the keyboard cable and keyboard backlight cable from the keyboard controller board.
8. Peel the keyboard controller board cable from the keyboard.
9. Remove the 38 screws (M1.2x1.4) and ten screws (M1.2x1.6) that secure the keyboard to the palm-rest assembly.
  - NOTE:** Peel off the three copper foil from the palm-rest assembly, and then peel off the two conductive tapes on the keyboard assembly to separate the keyboard assembly and the palm-rest assembly.
10. Lift the keyboard off the palm-rest assembly.

## Installing the keyboard assembly

### Prerequisites

If you are replacing a component, remove the existing component before performing the installation procedure.

### About this task

The following images indicate the location of keyboard assembly and provide a visual representation of the installation procedure.



**2x**  
M1.2x2.5



**38x**  
M1.2x1.4



**10x**  
M1.2x1.6

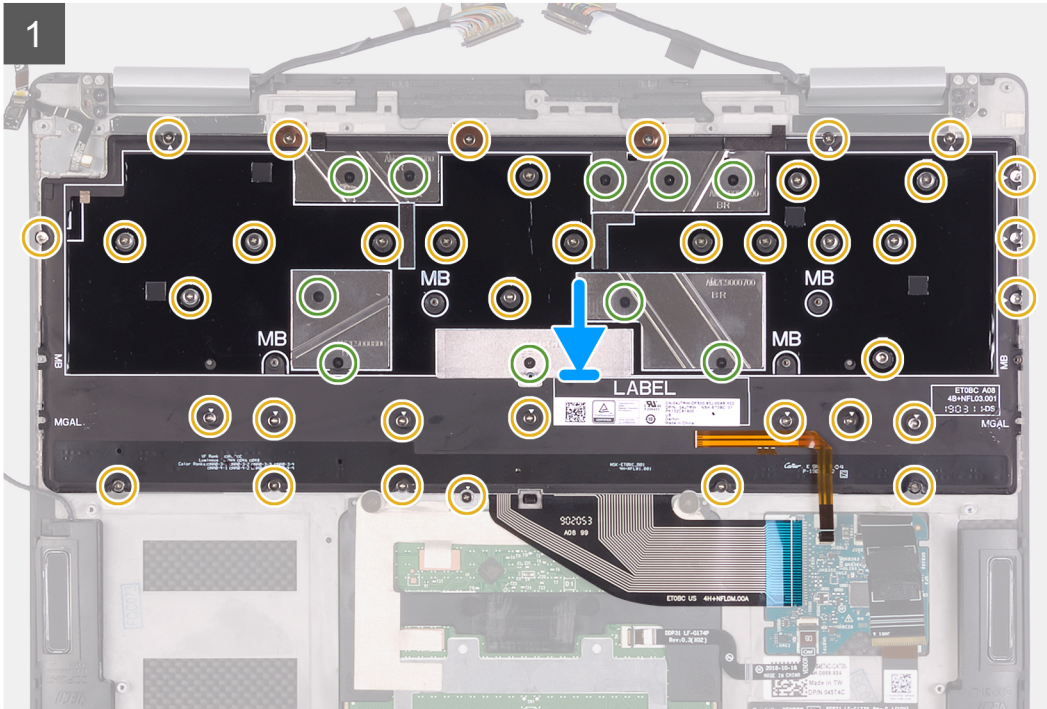
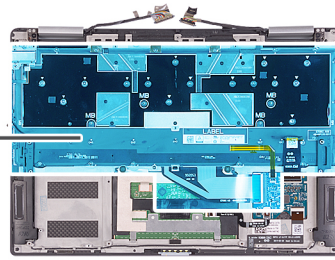



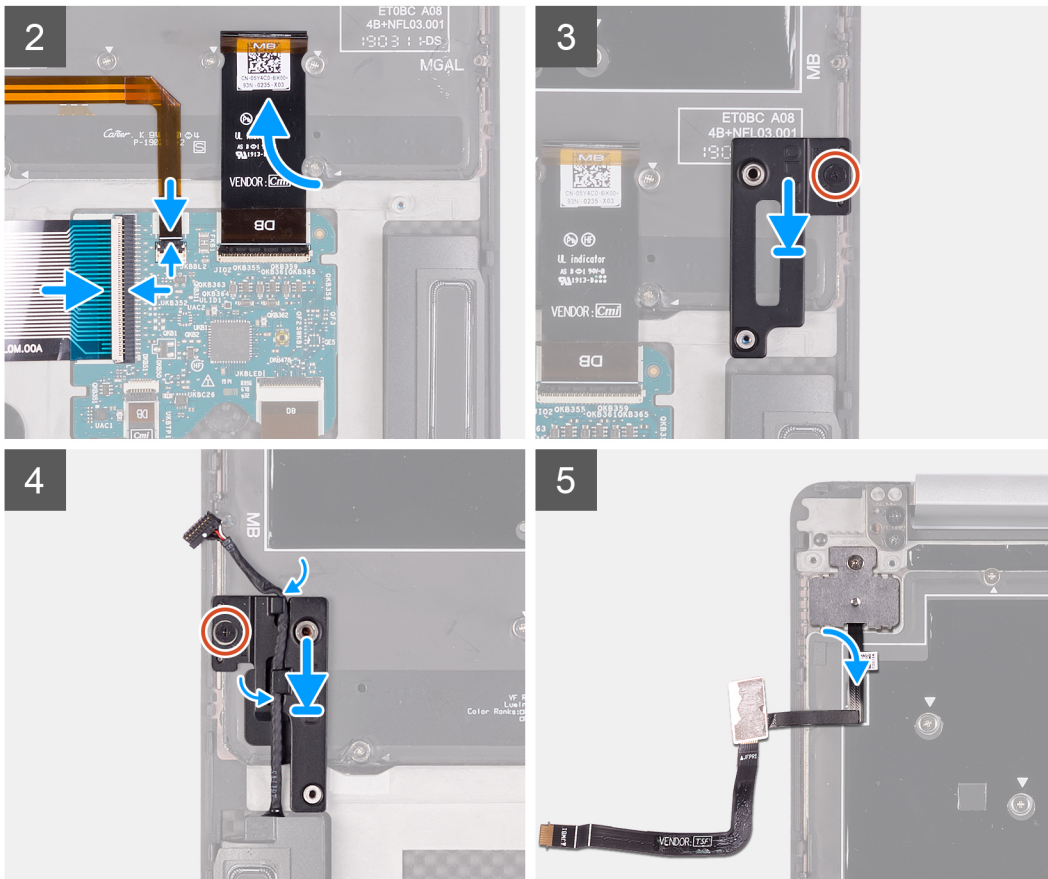

## Steps

- Align the screw holes on the keyboard with the screw holes on the palm-rest assembly.
  - NOTE:** Adhere the two conductive tapes on the keyboard, and then adhere the three copper foils on the palm-rest assembly to secure the keyboard assembly to the palm-rest assembly.
- Replace the 38 screws (M1.2x1.4) and ten screws (M1.2x1.6) that secure the keyboard to the palm-rest assembly.
  - NOTE:** Do not install keyboard assembly screws into locations that are marked with MB. Those screw holes are reserved for system board screws.
- Adhere the keyboard controller board cable to the keyboard.
- Connect the keyboard cable and keyboard backlight cable to the keyboard controller board.
- Adhere the right keyboard bracket in the slots on the palm-rest assembly.
- Tighten the captive screw that secures the right keyboard bracket to the palm-rest assembly.
- Adhere the right keyboard bracket in the slots on the palm-rest assembly.
- Tighten the captive screw that secures the left keyboard bracket to the palm-rest assembly.
- Route the speaker cable through the routing guides on the left keyboard assembly.
- Adhere the fingerprint reader cable to the keyboard.

## Next steps

- Install the [system board](#).
- Install the [battery](#).
- Install the [base cover](#).
- Follow the procedure in [After working inside your computer](#).

# Palm-rest assembly

## Removing the palm-rest assembly

### Prerequisites

1. Follow the procedure in [Before working inside your computer](#).
2. Remove the [base cover](#).
3. Remove the [battery](#).
4. Remove the [display assembly](#).
5. Remove the [speakers](#).
6. Remove the [system board](#).
7. Remove the [keyboard assembly](#).

### About this task

The following image indicates the palm-rest assembly and provides a visual representation of the removal procedure.

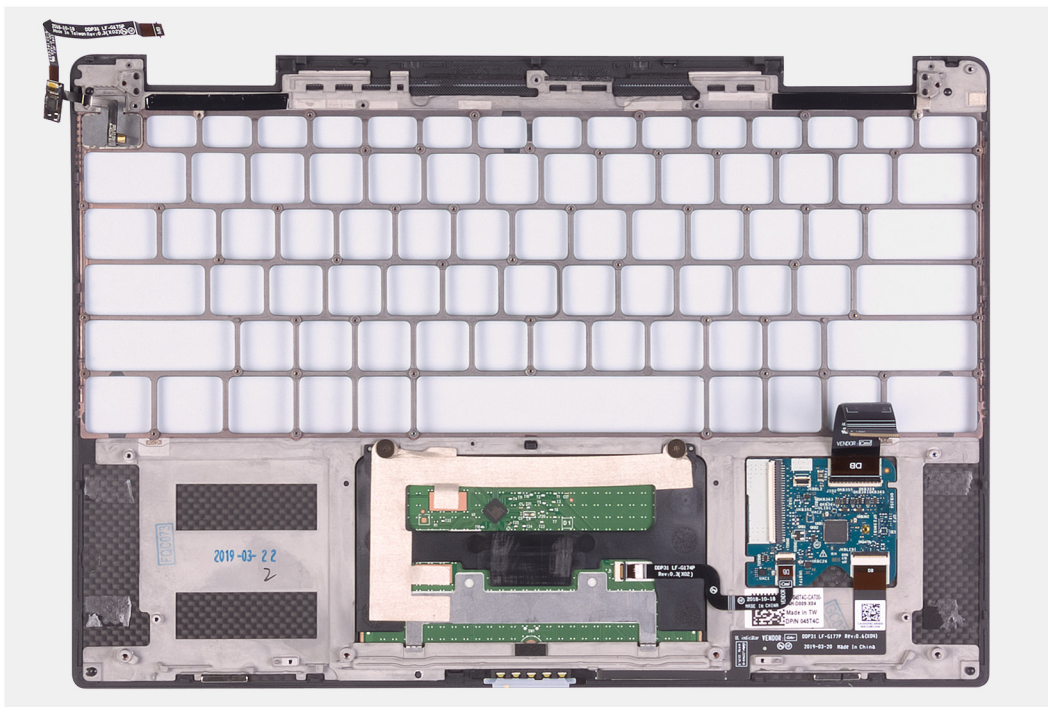

### Steps

The palm-rest assembly is left after performing the steps in the prerequisites.

**NOTE:** Keep the power-button and fingerprint reader bracket if you must replace the palm-rest assembly as the bracket is a separate service part for reuse.

**NOTE:** If the power-button and fingerprint reader bracket is not found on the palm-rest assembly, the bracket should be on the system board.

## Installing the palm-rest assembly

### Prerequisites

If you are replacing a component, remove the existing component before performing the installation procedure.

## About this task

The following image indicates the palm-rest assembly and provides a visual representation of the installation procedure.



## Steps

Place the palm-rest assembly on a flat surface.

**NOTE:** If you are installing components to a new palm-rest assembly, use the power-button and fingerprint reader bracket from the previous palm-rest assembly.

## Next steps

1. Install the [keyboard assembly](#).
2. Install the [system board](#).
3. Install the [speakers](#).
4. Install the [display assembly](#).
5. Install the [battery](#).
6. Install the [base cover](#).
7. Follow the procedure in [After working inside your computer](#).

## Drivers and downloads

When troubleshooting, downloading or installing drivers it is recommended that you read the Dell Knowledge Based article, Drivers and Downloads FAQ [SLN128938](#).



# System setup

**CAUTION:** Unless you are an expert computer user, do not change the settings in the BIOS Setup program. Certain changes can make your computer work incorrectly.

**NOTE:** Depending on the computer and its installed devices, the items listed in this section may or may not be displayed.

**NOTE:** Before you change BIOS Setup program, it is recommended that you write down the BIOS Setup program screen information for future reference.

Use the BIOS Setup program for the following purposes:

- Get information about the hardware installed in your computer, such as the amount of RAM and the size of the hard drive.
- Change the system configuration information.
- Set or change a user-selectable option, such as the user password, type of hard drive installed, and enabling or disabling base devices.

## BIOS overview

The BIOS manages data flow between the computer's operating system and attached devices such as hard disk, video adapter, keyboard, mouse, and printer.

## Entering BIOS setup program

### About this task

Turn on (or restart) your computer and press F2 immediately.

## Navigation keys

**NOTE:** For most of the System Setup options, changes that you make are recorded but do not take effect until you restart the system.

**Table 2. Navigation keys**

Keys	Navigation
Up arrow	Moves to the previous field.
Down arrow	Moves to the next field.
Enter	Selects a value in the selected field (if applicable) or follow the link in the field.
Spacebar	Expands or collapses a drop-down list, if applicable.
Tab	Moves to the next focus area. <b>NOTE:</b> For the standard graphics browser only.
Esc	Moves to the previous page until you view the main screen. Pressing Esc in the main screen displays a message that prompts you to save any unsaved changes and restarts the system.

# Boot Sequence

Boot Sequence allows you to bypass the System Setup–defined boot device order and boot directly to a specific device (for example: optical drive or hard drive). During the Power-on Self Test (POST), when the Dell logo appears, you can:

- Access System Setup by pressing F2 key
- Bring up the one-time boot menu by pressing F12 key

The one-time boot menu displays the devices that you can boot from including the diagnostic option. The boot menu options are:

- Removable Drive (if available)
- STXXXX Drive (if available)
  - **NOTE:** XXX denotes the SATA drive number.
- Optical Drive (if available)
- SATA Hard Drive (if available)
- Diagnostics

The boot sequence screen also displays the option to access the System Setup screen.

# System setup options

**NOTE:** Depending on this computer and its installed devices, the items that are listed in this section may or may not be displayed.

**Table 3. System setup options—System information menu**

Overview	
BIOS Version	Displays the BIOS version number.
Service Tag	Displays the Service Tag of the computer.
Asset Tag	Displays the Asset Tag of the computer.
Ownership Tag	Displays the ownership tag of the computer.
Manufacture Date	Displays the manufacture date of the computer.
Ownership Date	Displays the ownership date of the computer.
Express Service Code	Displays the express service code of the computer.
Ownership Tag	Displays the ownership tag of the computer.
Signed Firmware Update	Displays whether the signed firmware update is enabled.
<b>Battery</b>	Displays the battery health information.
Primary	Displays the primary battery.
Battery Level	Displays the battery level.
Battery State	Displays the battery state.
Health	Displays the battery health.
AC Adapter	Displays whether an AC adapter is installed.
<b>Processor Information</b>	
Processor Type	Displays the processor type.
Maximum Clock Speed	Displays the maximum processor clock speed.
Core Count	Displays the number of cores on the processor.
Processor L2 Cache	Displays the processor L2 Cache size.
Processor ID	Displays the processor identification code.

**Table 3. System setup options—System information menu (continued)**

<b>Overview</b>	
Processor L3 Cache	Displays the processor L3 Cache size.
Current Clock Speed	Displays the current processor clock speed.
Minimum Clock Speed	Displays the minimum processor clock speed.
Microcode Version	Displays the microcode version.
Intel Hyper-Threading Capable	Displays whether the processor is Hyper-Threading (HT) capable.
64-Bit Technology	Displays whether 64-bit technology is used.
<b>Memory Information</b>	
Memory Installed	Displays the total computer memory installed.
Memory Available	Displays the total computer memory available.
Memory Speed	Displays the memory speed.
Memory Channel Mode	Displays single or dual channel mode.
Memory Technology	Displays the technology that is used for the memory.
<b>Device Information</b>	
Video Controller	Displays the integrate graphics information of the computer.
Video BIOS Version	Displays the video BIOS version of the computer.
Video Memory	Displays the video memory information of the computer.
Panel Type	Displays the Panel Type of the computer.
Native Resolution	Displays the native resolution of the computer.
Audio Controller	Displays the audio controller information of the computer.
Wi-Fi Device	Displays the wireless device information of the computer.
Bluetooth Device	Displays the Bluetooth device information of the computer.

**Table 4. System setup options—Boot options menu**

<b>Boot options</b>	
<b>Advanced Boot Options</b>	
Enable UEFI Network Stack	Enables or disables UEFI Network Stack. Default: OFF.
<b>Boot Mode</b>	
Boot Mode: UEFI only	Displays the boot mode of this computer.
Enable Boot Devices	Enables or disables boot devices for this computer.
Boot Sequence	Displays the boot sequence.
<b>BIOS Setup Advanced Mode</b>	Enables or disables advanced BIOS settings. Default: ON.
<b>UEFI Boot Path Security</b>	Enables or disables the system to prompt the user to enter the Admin password when booting a UEFI boot path from the F12 boot menu. Default: Always Except Internal HDD.

**Table 5. System setup options—System Configuration menu**

<b>System Configuration</b>
<b>Date/Time</b>

**Table 5. System setup options—System Configuration menu (continued)**

<b>System Configuration</b>	
Date	Sets the computer date in MM/DD/YYYY format. Changes to the date take effect immediately.
Time	Sets the computer time in HH/MM/SS 24-hour format. You can switch between 12-hour and 24-hour clock. Changes to the time take effect immediately.
<b>Storage Interface</b>	
Port Enablement	Enables the selected onboard drives.
<b>SATA Operation</b>	Configures operating mode of the integrated SATA hard drive controller. Default: RAID. SATA is configured to support RAID (Intel Rapid Restore Technology).
<b>Drive Information</b>	Displays the information of various onboard drives.
<b>Enable Audio</b>	Enables or disables all integrated audio controller. Default: ON.
Enable Microphone	Enables or disables microphone. Default: ON.
Enable Internal Speaker	Enables or disables internal speaker. Default: ON.
<b>USB Configuration</b>	
Enable Boot Support	Enables or disables booting from USB mass storage devices such as external hard drive, optical drive, and USB drive. Default: ON.
Enable External USB Ports	Enables or disables USB ports to be functional in an operating system environment. Default: ON.
Enable Thunderbolt Technology Support	Enables or disables Thunderbolt Technology Support. Default: ON.
Enable Thunderbolt Boot Support	Enables or disables Thunderbolt Boot Support. Default: OFF.
<b>Miscellaneous Devices</b>	
Enable Camera	Enables or disables the camera. Default: ON.
Touchscreen	Enables or disables the touchscreen for the operating system.  <b>NOTE:</b> Touchscreen will always work in the BIOS setup irrespective of this setting. Default: ON.
Enable Fingerprint Reader Device	Enables or disables the Fingerprint Reader Device. Default: ON.
Enable Fingerprint Reader Single Sign On	Enables or disables the Fingerprint Reader Device's Single Sign On capability. Default: ON.
<b>Enable MediaCard</b>	Enables to switch all media cards On/Off or set the media card to read-only state.

**Table 5. System setup options—System Configuration menu (continued)**

<b>System Configuration</b>	
	Default: Enable Secure Digital (SD) Card.
<b>Keyboard Illumination</b>	Configures the operating mode of the keyboard illumination feature. Default: Bright. Enable the keyboard illumination feature at 100% brightness level.
<b>Keyboard Backlight Timeout on AC</b>	Configures the timeout value for the keyboard when an AC adapter is connected to the computer. The keyboard backlight timeout value is only effect when the backlight is enabled. Default: 10 seconds.
<b>Keyboard Backlight Timeout on Battery</b>	Configures the timeout value for the keyboard when the computer is running on battery. The keyboard backlight timeout value is only effect when the backlight is enabled. Default: 10 seconds.

**Table 6. System setup options—Video menu**

<b>Video</b>	
<b>LCD Brightness</b>	
Brightness on battery power	Sets the screen brightness when the computer is running on battery power.
Brightness on AC power	Sets the screen brightness when the computer is running on AC power.

**Table 7. System setup options—Security menu**

<b>Security</b>	
Enable Admin Setup Lockout	Enables or disables the user from entering BIOS Setup when an Admin Password is set. Default: OFF.
Password Bypass	Bypass the System (Boot) Password and the internal hard drive password prompts during a system restart. Default: Disabled.
Enable Non-Admin Password Changes	Enables or disables the user to change the system and hard drive password without the need for admin password. Default: ON.
<b>Non-Admin Setup Changes</b>	
Allow Wireless Switch Changes	Enables or disables changes to the setup option when an Administrator password is set. Default: OFF.
Enable UEFI Capsule Firmware Updates	Enables or disables BIOS updates through UEFI capsule update packages.
<b>Absolute</b>	Enables, disables or permanently disable the BIOS module interface of the optional Absolute Persistence Module service from Absolute Software. Default: Enable Absolute.
TPM 2.0 Security On	Select whether or not the Trusted Platform Model (TPM) is visible to the OS. Default: ON.
PPI Bypass for Enable Commands	Enables or disables the OS to skip BIOS Physical Presence Interface (PPI) user prompts when issuing TPM PPI enabled and activate commands. Default: OFF.



**Table 7. System setup options—Security menu (continued)**

<b>Security</b>	
PPI Bypass for Disable Commands	Enables or disables The OS to skip BIOS PPI user prompts when issuing TPM PPI Disable and Deactivate commands.  Default: OFF.
PPI Bypass for Clear Commands	Enables or disables the operating system to skip BIOS Physical Presence Interface (PPI) user prompts when issuing the Clear command.  Default: OFF.
Attestation Enables	Enables to control whether the TPM Endorsement Hierarchy is available to the OS. Disabling this setting restricts the ability to use the TPM for signature operations.  Default: ON.
Key Storage Enable	Enables to control whether the TPM Endorsement Hierarchy is available to the OS. Disabling this setting restricts the ability to use the TPM for storing owner data.  Default: ON.
SHA-256	Enables or disables the BIOS and the TPM to use the SHA-256 hash algorithm to extend measurements into the TPM PCRs during BIOS boot.  Default: ON.
Clear	Enables or disables the computer to clear the PTT owner information, and returns the PTT to the default state.  Default: OFF.
TPM State	Enables or disables the TPM. This is the normal operating state for the TPM when you want to use its complete array of capabilities.  Default: Enabled.
<b>Intel SGX</b>	Enables or disables the Intel Software Guard Extensions (SGX) to provide a secured environment for running code/storing sensitive information.  Default: Software Control
<b>SMM Security Mitigation</b>	Enables or disables additional UEFI SMM Security Mitigation protections. Default: OFF.   <b>NOTE:</b> This feature may cause compatibility issues or loss of functionality with some legacy tools and applications.
Enable Strong Passwords	Enables or disables strong passwords.  Default: OFF.
<b>Password Configuration</b>	Control the minimum and maximum number of characters that are allowed for Admin and System passwords.
<b>Admin Password</b>	Sets, Changes, or deletes the administrator (admin) password (sometimes called the "setup" password).
<b>System Password</b>	Sets, Changes, or deletes the system password.
Enable Master Password Lockout	Enables or disables the master password support.  Default: OFF.

**Table 8. System setup options—Secure Boot menu**

<b>Secure Boot</b>	
Enable Secure Boot	Enables or disables the computer to boots using only validated boot software.

**Table 8. System setup options—Secure Boot menu (continued)**

<b>Secure Boot</b>	
	<p>Default: OFF.</p> <p><b>NOTE:</b> For Secure Boot to be enabled, the computer needs to be in UEFI boot mode and the Enable Legacy Option ROMs option needs to be turned off.</p>
Secure Boot Mode	<p>Selects the Secure Boot operation mode.</p> <p>Default: Deployed Mode.</p> <p><b>NOTE:</b> Deployed Mode should be selected for normal operation of Secure Boot.</p>

**Table 9. System setup options—Expert Key Management menu**

<b>Expert Key Management</b>	
Enable Custom Mode	<p>Enables or disables the keys in the PK, KEK, db, and dbx security key databases to be modified.</p> <p>Default: OFF.</p>
Custom Mode Key Management	<p>Selects the custom values for expert key management.</p> <p>Default: PK.</p>

**Table 10. System setup options—Performance menu**

<b>Performance</b>	
Intel Hyper-Threading Technology	<p>Enables or disables the Intel Hyper-Threading Technology to use processor resources more efficiently.</p> <p>Default: ON.</p>
Intel SpeedStep	<p>Enables or disables the Intel SpeedStep Technology to dynamically adjust processor voltage and core frequency, decreasing average power consumption and heat production.</p> <p>Default: ON.</p>
Intel TurboBoost Technology	<p>Enabled or disabled the Intel TurboBoost mode of the processor. If enabled, the Intel TurboBoost driver increases the performance of the CPU or graphics processor.</p> <p>Default: ON.</p>
Multi-Core Support	<p>Changes the number of CPU cores available to the operating system. The default value is set to the maximum number of cores.</p> <p>Default: All Cores.</p>
Enable C-State Control	<p>Enables or disables the CPU's ability to enter and exit low-power states.</p> <p>Default: ON.</p>

**Table 11. System setup options—Power Management menu**

<b>Power Management</b>	
Wake on AC	<p>Enables the computer to turn on and go to boot when AC power is supplied to the computer.</p> <p>Default: OFF.</p>
Wake on Dell USB-C Dock	<p>Enables connecting a Dell USB-C Dock to wake the computer from Standby.</p> <p>Default: ON.</p>

**Table 11. System setup options—Power Management menu (continued)**

<b>Power Management</b>	
Auto on Time	Enables the computer to automatically power on for defined days and times. Default: Disabled. The system will not automatically power up.
Battery Charge Configuration	Enables the computer to run on battery during power usage hours. Use the below options to prevent AC power usage between certain times of each day. Default: Adaptive. Battery settings are adaptively optimized based on your typical battery usage pattern.
Enable Advanced Battery Charge Configuration	Enables Advanced Battery Charge Configuration from the beginning of the day to a specified work period. Advanced Battery Charged maximizes battery health while still supporting heavy use during the work day. Default: OFF.
Block Sleep	Blocks the computer from entering Sleep (S3) mode in the operating system. Default: OFF. <b>NOTE:</b> If enabled, the computer will not go to sleep, Intel Rapid Start will be disabled automatically, and the operating system power option will be blank if it was set to Sleep.
Peak Shift	Enables the computer to run on battery during peak power usage hours. Default: OFF.
<b>Wireless Radio Control</b>	Enables to sense the connection of the computer to a wired network and subsequently disable the selected wireless radios (WLAN and/or WWAN). Upon disconnection from the wired network, the selected wireless radios are re-enabled. Default: OFF.
<b>Wake on LAN</b>	Enables or disables the computer to turn on by a special LAN signal. Default: Disabled.
Intel Speed Shift Technology	Enables or disables the Intel Speed Shift Technology support. Setting this option to enable allows the operating system to select the appropriate processor performance automatically. Default: ON.
<b>Lid Switch</b>	Enables the computer to power up from the off state whenever the lid is opened. Default: ON.

**Table 12. System setup options—Wireless menu**

<b>Wireless</b>	
<b>Wireless Device Enable</b>	Enable or disable internal WLAN/Bluetooth devices.
WLAN	Default: ON.
Bluetooth	Default: ON.

**Table 13. System setup options—POST Behavior menu**

<b>POST Behavior</b>	
Numlock Enable	Enables or disables Numlock when the computer boots. Default: ON.
Enable Adapter Warnings	Enables the computer to display adapter warning messages during boot.

**Table 13. System setup options—POST Behavior menu (continued)**

<b>POST Behavior</b>	
Extend BIOS POST Time	Default: ON. Configures the BIOS POST (Power-On Self-Test) load time. Default: 0 seconds.
Fastboot	Configures the speed of the UEFI boot process. Default: Thorough. Performs complete hardware and configuration initialization during boot.
Fn Lock Options	Enables or disables the Fn lock mode. Default: ON.
Lock Mode	Default: Lock Mode Secondary. Lock Mode Secondary = If this option is selected, the F1-F12 keys scan the code for their secondary functions.
Full Screen Logo	Enabled or disabled the computer to display full screen logo if the image match screen resolution. Default: OFF.
Warnings and Errors	Selects an action on encountering a warning or error during boot. Default: Prompt on Warnings and Errors. Stop, prompt, and wait for user input when warnings or errors are detected. <b>NOTE:</b> Errors deemed critical to the operation of the computer hardware will always halt the computer.
Mouse/Touchpad	Defines how the computer handles mouse and touchpad input. Default: Touchpad and PS/2 Mouse. Leave the integrated touchpad enabled when an external PS/2 mouse is present.
<b>Sign of Life</b>	
Early Logo Display	Display Logo Sign of Life. Default: ON.
Early Keyboard Backlight	Keyboard Backlight Sign of Life. Default: ON.
<b>MAC Address Pass-Through</b>	Replaces the external NIC MAC address (in a supported dock or dongle) with the selected MAC address from the computer. Default: System Unique MAC Address.

**Table 14. System setup options—Virtualization menu**

<b>Virtualization</b>	
Intel Virtualization Technology	Enables the computer to run a virtual machine monitor (VMM). Default: ON.
VT for Direct I/O	Enables the computer to perform Virtualization Technology for Direct I/O (VT-d). VT-d is an Intel method that provides virtualization for memory map I/O. Default: ON.

**Table 15. System setup options—Maintenance menu**

<b>Maintenance</b>	
Asset Tag	Creates a system Asset Tag that can be used by an IT administrator to uniquely identify a particular system. Once set in BIOS, the Asset Tag cannot be changed.
Service Tag	Displays the Service Tag of the computer.
BIOS Recovery from Hard Drive	Enables the computer to recover from a bad BIOS image, as long as the Boot Block portion is intact and functioning. Default: ON. <b>NOTE:</b> BIOS recovery is designed to fix the main BIOS block and cannot work if the Boot Block is damaged. In addition, this feature cannot work in the event of EC corruption, ME corruption, or a hardware issue. The recovery image must exist on an unencrypted partition on the drive.
BIOS Auto-Recovery	Enables the computer to automatically recover the BIOS without user actions. This feature requires BIOS Recovery from Hard Drive to be set to Enabled. Default: OFF.
Start Data Wipe	<b>CAUTION: This Secure Wipe Operation deletes information in a way that it cannot be reconstructed.</b> If enabled, the BIOS will queue up a data wipe cycle for storage devices that are connected to the motherboard on the next reboot. Default: OFF.
Allow BIOS Downgrade	Controls flashing of the system firmware to previous revisions. Default: ON.

**Table 16. System setup options—System Logs menu**

<b>System Logs</b>	
Power Event Log	Displays Power events. Default: Keep.
BIOS Event Log	Displays BIOS events. Default: Keep.
Thermal Event Log	Displays Thermal events. Default: Keep.

**Table 17. System setup options—SupportAssist menu**

<b>SupportAssist</b>	
Dell Auto operating system Recovery Threshold	Controls the automatic boot flow for SupportAssist System Resolution Console and for Dell operating system Recovery tool. Default: 2.
SupportAssist operating system Recovery	Enables or disables the boot flow for SupportAssist operating system Recovery tool in the even of certain system errors. Default: ON.



# Clearing CMOS settings

## About this task

 **CAUTION:** Clearing CMOS settings will reset the BIOS settings on your computer.

## Steps

1. Remove the [base cover](#).
2. Disconnect the battery cable from the system board.
3. Wait for one minute.
4. Connect the battery cable to the system board.
5. Replace the [base cover](#).

# Clearing BIOS (System Setup) and System passwords

## About this task

To clear the system or BIOS passwords, contact Dell technical support as described at [www.dell.com/contactdell](http://www.dell.com/contactdell).

 **NOTE:** For information on how to reset Windows or application passwords, refer to the documentation accompanying Windows or your application.

# Troubleshooting

## Locate the Service Tag or Express Service Code of your Dell computer

Your Dell computer is uniquely identified by a Service Tag or Express Service Code. To view relevant support resources for your Dell computer, we recommend entering the Service Tag or Express Service Code at [www.dell.com/support](http://www.dell.com/support).

For more information on how to find the Service Tag for your computer, see [Locate the Service Tag for your Dell Laptop](#).

## Recovering the operating system

When your computer is unable to boot to the operating system even after repeated attempts, it automatically starts Dell SupportAssist OS Recovery.

Dell SupportAssist OS Recovery is a standalone tool that is preinstalled in all Dell computers installed with Windows 10 operating system. It consists of tools to diagnose and troubleshoot issues that may occur before your computer boots to the operating system. It enables you to diagnose hardware issues, repair your computer, back up your files, or restore your computer to its factory state.

You can also download it from the Dell Support website to troubleshoot and fix your computer when it fails to boot into their primary operating system due to software or hardware failures.

For more information about the Dell SupportAssist OS Recovery, see *Dell SupportAssist OS Recovery User's Guide* at [www.dell.com/support](http://www.dell.com/support).

## SupportAssist | On-board Diagnostics

### About this task

The SupportAssist | On-board Diagnostics performs a complete check of your hardware.

This diagnostic is the new on-board diagnostic tool and replaces the ePSA 3.0 diagnostics. It has a clean and modern user interface, quicker tests, simplified messaging.

SupportAssist | On-board Diagnostics can be initiated by one of the following methods:

- Pressing F12 to enter one-time Boot Menu and selecting Diagnostics to initiate the diagnostics OR Fn + Power
- BIOS POST detecting a hardware failure or error and initiating the diagnostics

The SupportAssist | On-board Diagnostics is embedded with the BIOS and is launched by the BIOS internally. The embedded system diagnostics provides a set of options for particular devices or device groups allowing you to:

- Run tests in either Quick Test Mode or Advanced Test Mode
- Run thorough tests to introduce additional test options to provide extra information about the failed device(s)
- Run tests in either Automatic Mode or Interactive Test Mode
- Run interactive tests on LCD panel and keyboard
- Display or save test results
- View status messages that indicate if the tests are completed successfully
- View error messages that indicate if problems were encountered during the test

 **NOTE:** Some tests for specific devices require user interaction. Ensure that you are present at the computer terminal when the diagnostic tests are performed.

For more information, see [SupportAssist Pre-Boot System Performance Check](#).

# System diagnostic lights

When static, the power and battery-charge status light indicates the power mode that your computer is in. When blinking in different patterns, the power and battery-charge status light indicates the respective issues that your computer is encountering.

## Static power and battery-charge status light

The following table lists the status of your computer based on the power and battery-charge status light.

**Table 18. Power and battery-charge status light**

Power and battery-charge status light	Status of computer
<b>Solid white</b>	<ul style="list-style-type: none"> <li>The power adapter is connected and the battery is fully charged.</li> <li>The power adapter is connected and the battery has more than five percent charge.</li> </ul>
<b>Amber</b>	The computer is running on battery and the battery has less than five percent charge.
<b>Off</b>	The computer is in sleep state, hibernation, or turned off.

## Blinking power and battery-charge status light

The power and battery-status light blinks alternately between amber and off to indicate issues that your computer is encountering.

For example, the power and battery-status light blinks amber two times followed by a pause, and then blinks white three times followed by a pause. This 2,3 pattern continues until the computer is turned off indicating no memory or RAM is detected.

The following table shows the different power and battery-status light patterns and the associated issues.

**Table 19. LED codes**

Diagnostic light codes	Problem description
<b>2,1</b>	Processor failure
<b>2,2</b>	System board: BIOS or ROM (Read-Only Memory) failure
<b>2,3</b>	No memory or RAM (Random-Access Memory) detected
<b>2,4</b>	Memory or RAM (Random-Access Memory) failure
<b>2,5</b>	Invalid memory installed
<b>2,6</b>	System-board or chipset error
<b>2,7</b>	Display failure
<b>2,8</b>	LCD power rail failure.
<b>3,1</b>	CMOS battery failure
<b>3,2</b>	PCI, video card/chip failure
<b>3,3</b>	Recovery image not found
<b>3,4</b>	Recovery image found but invalid
<b>3,5</b>	Power-rail failure
<b>3,6</b>	System BIOS Flash incomplete
<b>3,7</b>	Management Engine (ME) error

# Flashing the BIOS

## About this task

You may need to flash (update) the BIOS when an update is available or when you replace the system board.

Follow these steps to flash the BIOS:

## Steps

1. Turn on your computer.
2. Go to [www.dell.com/support](http://www.dell.com/support).
3. Click **Product support**, enter the Service Tag of your computer, and then click **Submit**.

 **NOTE:** If you do not have the Service Tag, use the auto-detect feature or manually browse for your computer model.

4. Click **Drivers & downloads > Find it myself**.
5. Select the operating system installed on your computer.
6. Scroll down the page and expand **BIOS**.
7. Click **Download** to download the latest version of the BIOS for your computer.
8. After the download is complete, navigate to the folder where you saved the BIOS update file.
9. Double-click the BIOS update file icon and follow the instructions on the screen.

# Flashing BIOS (USB key)

## Steps

1. Follow the procedure from step 1 to step 7 in "Flashing the BIOS" to download the latest BIOS setup program file.
2. Create a bootable USB drive. For more information see the knowledge base article [SLN143196](https://www.dell.com/support/sln/SLN143196) at [www.dell.com/support](http://www.dell.com/support).
3. Copy the BIOS setup program file to the bootable USB drive.
4. Connect the bootable USB drive to the computer that needs the BIOS update.
5. Restart the computer and press **F12** when the Dell logo is displayed on the screen.
6. Boot to the USB drive from the **One Time Boot Menu**.
7. Type the BIOS setup program filename and press **Enter**.
8. The **BIOS Update Utility** appears. Follow the instructions on the screen to complete the BIOS update.

# WiFi power cycle

## About this task

If your computer is unable to access the Internet due to WiFi connectivity issues, a WiFi power cycle procedure may be performed. The following procedure provides the instructions on how to conduct a WiFi power cycle:

 **NOTE:** Some ISPs (Internet Service Providers) provide a modem/router combo device.

## Steps

1. Turn off your computer.
2. Turn off the modem.
3. Turn off the wireless router.
4. Wait for 30 seconds.
5. Turn on the wireless router.
6. Turn on the modem.
7. Turn on your computer.

# Flea power release

## About this task

Flea power is the residual static electricity that remains on the computer even after it has been powered off and the battery has been removed. The following procedure provides the instructions on how to conduct flea power release:

## Steps

1. Turn off your computer.
2. Remove the [base cover](#).
3. Remove the [battery](#).
4. Press and hold the power button for 15 seconds to drain the flea power.
5. Replace the [battery](#).
6. Replace the [base cover](#).
7. Turn on your computer.





# Getting help and contacting Dell

## Self-help resources

You can get information and help on Dell products and services using these self-help resources:

**Table 20. Self-help resources**

Self-help resources	Resource location
Information about Dell products and services	<a href="http://www.dell.com">www.dell.com</a>
My Dell app	
Tips	
Contact Support	In Windows search, type <code>Contact Support</code> , and press Enter.
Online help for operating system	<a href="http://www.dell.com/support/windows">www.dell.com/support/windows</a>
Access top solutions, diagnostics, drivers and downloads, and learn more about your computer through videos, manuals and documents.	Your Dell computer is uniquely identified by a Service Tag or Express Service Code. To view relevant support resources for your Dell computer, enter the Service Tag or Express Service Code at <a href="http://www.dell.com/support">www.dell.com/support</a> .  For more information on how to find the Service Tag for your computer, see <a href="#">Locate the Service Tag for your Dell Laptop</a> .
Dell knowledge base articles for a variety of computer concerns	<ol style="list-style-type: none"> <li>1. Go to <a href="http://www.dell.com/support">www.dell.com/support</a>.</li> <li>2. On the menu bar at the top of the Support page, select <b>Support &gt; Knowledge Base</b>.</li> <li>3. In the Search field on the Knowledge Base page, type the keyword, topic, or model number, and then click or tap the search icon to view the related articles.</li> </ol>

## Contacting Dell

To contact Dell for sales, technical support, or customer service issues, see [www.dell.com/contactdell](http://www.dell.com/contactdell).

 **NOTE:** Availability varies by country/region and product, and some services may not be available in your country/region.

 **NOTE:** If you do not have an active Internet connection, you can find contact information about your purchase invoice, packing slip, bill, or Dell product catalog.